



**BUREAU  
VERITAS**

# Certificado de conformidade

**Número do certificado:** 1788AP1019N017002  
**Produto:** Grid tied fotovoltaic inverter  
**Nome de Marca:**   
**Modelo:** SOFAR 3000TL  
**Requerente:** Shenzhen Sofarsolar Co.,Ltd  
5/F, Building 4, Antongda Industrial Park, No.1 Liuxian Avenue,Xin'an Street,  
Bao'an District, Shenzhen City, Guangdong Province,P.R. China  
**Número do relatório:** PVBR171019N017-1

## Uso em conformidade com os regulamentos:

Dispositivo de desconexão automática com vigilância de rede monofásica, de acordo com a norma ABNT NBR 16149:2013 (ABNT NBR 16150:2013) para sistemas fotovoltaicos com acoplamento paralelo monofásico através de um inversor na rede elétrica pública. O dispositivo de desconexão automática é parte integrante dos inversores já mencionados.

## Regras e normas aplicadas

**ABNT NBR 16149:2013** Sistemas fotovoltaicos (FV) – Características da interface de conexão com a rede elétrica de distribuição  
**ABNT NBR 16150:2013** Sistemas fotovoltaicos (FV) – Características da interface de conexão com a rede elétrica de distribuição – Procedimento de ensaio de conformidade  
**ABNT NBR IEC 62116:2012** Procedimento de ensaio de anti-ilhamento para inversores de sistemas fotovoltaicos conectados à rede elétrica

No momento da emissão deste certificado, o conceito de segurança de um produto representativo acima mencionado corresponde às especificações de segurança válidas para a utilização especificada, de acordo com os regulamentos.



**Ted Wu/ Gerente sênior**  
Data: 2017-12-21

This document shall not be reproduced, except in full, without the written approval of Bureau Veritas Shenzhen Co., Ltd. Dongguan Branch.  
Information given in this document is related to the tested specimen of the described electrical sample.





**BUREAU  
VERITAS**

# TEST REPORT ABNT NBR 16150

**Sistemas fotovoltaicos (FV) – Características da interface de conexão com a rede elétrica de distribuição – Procedimento de ensaio de conformidade**

<b>Report reference number</b> .....	<b>PVBR171019N017-1</b>
Date of issue .....	2017-11-21
Total number of pages .....	55
<b>Testing laboratory name</b> .....	<b>Bureau Veritas Shenzhen Co., Ltd. Dongguan Branch</b>
Address .....	No. 34, Chenwulu Section, Guantai Rd., Houjie Town, Dongguan City, Guangdong 523942, China
	 
<b>Applicant's name</b> .....	<b>Shenzhen Sofarsolar Co.,Ltd</b>
Address .....	5/F, Building 4, Antongda Industrial Park, No.1 Liuxian Avenue, Xin'an Street, Bao'an District, Shenzhen City, Guangdong Province, P.R. China
<b>Test specification</b>	
Standard .....	ABNT NBR 16149:2013 ABNT NBR 16150:2013 IEC 62116:2008, EN 62116:2011, DIN EN 62116:2012, ABNT NBR IEC 62116:2012
<b>Certificate</b> .....	<b>Certificate of compliance</b>
Test report form number .....	ABNT NBR 16150
Master TRF .....	Bureau Veritas Shenzhen Co., Ltd. Dongguan Branch
<b>Test item description</b> .....	<b>Grid tied photovoltaic inverter</b>
Trademark .....	
Model / Type .....	SOFAR 3000TL
<b>Ratings</b> .....	<b>See below</b>
MPP DC voltage range [V] .....	200-500
Input DC voltage range [V] .....	100-500
Input DC current [A] .....	13
Output AC voltage [V] .....	220Vac, 60Hz
Output AC current [A] .....	13
Output power [VA] .....	3000













<b>Testing Location</b> .....	<b>Bureau Veritas Shenzhen Co., Ltd., Dongguan Branch</b>
<b>Address</b> .....	No.34, Chenwulu Section, Guantai Rd., Houjie Town, Dongguan City, Guangdong Province 523942, China
<b>Tested by</b> (name and signature).....	James Huang 
<b>Approved by</b> (name and signature).....	Ted Wu 
<b>Manufacturer's name</b> .....	<b>Shenzhen Sofarsolar Co.,Ltd</b>
<b>Factory address</b> .....	5/F, Building 4, Antongda Industrial Park, No.1 Liuxian Avenue, Xin'an Street, Bao'an District, Shenzhen City, Guangdong Province, P.R. China

<b>Document History</b>			
<b>Date</b>	<b>Internal reference</b>	<b>Modification / Change / Status</b>	<b>Revision</b>
2017-11-21	James Huang	Initial report was written	--
Supplementary information:			

<b>Test items particulars</b>	
Equipment mobility.....	: Permanent connection
Operating condition.....	: Continuous
Class of equipment.....	: Class I
Protection against ingress of water..	: IP65 according to EN 60529
Mass of equipment [kg].....	: 12
<b>Test case verdicts</b>	
Test case does not apply to the test object.....	: N/A
Test item does meet the requirement.....	: P(ass)
Test item does not meet the requirement.....	: F(ail)
<b>Testing</b>	
Date of receipt of test item.....	: 2017-10-19
Date(s) of performance of test.....	: 2017-10-19 till 2017-11-10
<b>General remarks:</b>	
<p>The test result presented in this report relate only to the object(s) tested.          This report must not be reproduced in part or in full without the written approval of the issuing testing laboratory.</p> <p>"(see Annex #)" refers to additional information appended to the report.          "(see appended table)" refers to a table appended to the report.</p> <p>Throughout this report a comma is used as the decimal separator.</p>	
<b>This Test Report consists of the following documents:</b>	
<ol style="list-style-type: none"> <li>1. Test Results</li> <li>2. Annex No. 1 – Pictures of the unit</li> <li>3. Annex No. 2 – Test equipment list</li> </ol>	

Copy of marking plate:

PV Inverter

Model No.	SOFAR 3000TL
Vmax. DC input voltage	500V
DC input voltage range	100-500V
Imax. DC input current	13A
Isc(max.) DC current	15A
Nominal grid voltage	220/230V
Nominal AC output current	13A
Nominal grid frequency	50/60Hz
Nominal output power	3000VA
Power factor	1(adjustable+/-0.8)
Ingress protection	IP65
Operating temperature range	-25-+60°C
Protective class	Class I
Made in China	
Manufacturer: Shenzhen SOFARSOLAR Co., Ltd. Address: 5/F Building 4, Antongda Industrial Park, NO.1 Luxian Avenue, Xin'an Street, Bao'an District, Shenzhen City, Guangdong Province, P.R. China	
 SAA161894 VDE0126-1-1, VDE-AR-N 4105, G83/2, EN50438, C10/11, AS4777, RD1699, UTE C15-712-1	
        	

### General product information:

The Solar Inverter converts DC voltage into AC voltage.

When combined as a system, the plant should be lower than 100kW.

The input and output are protected by varistors to Earth. The unit is providing EMC filtering at the PV input and output toward mains. The unit does not provide galvanic separation from input to output (transformerless). The output is switched off redundantly by the high power switching bridge and two relays. This assures that the opening of the output circuit will also operate in case of a single error.

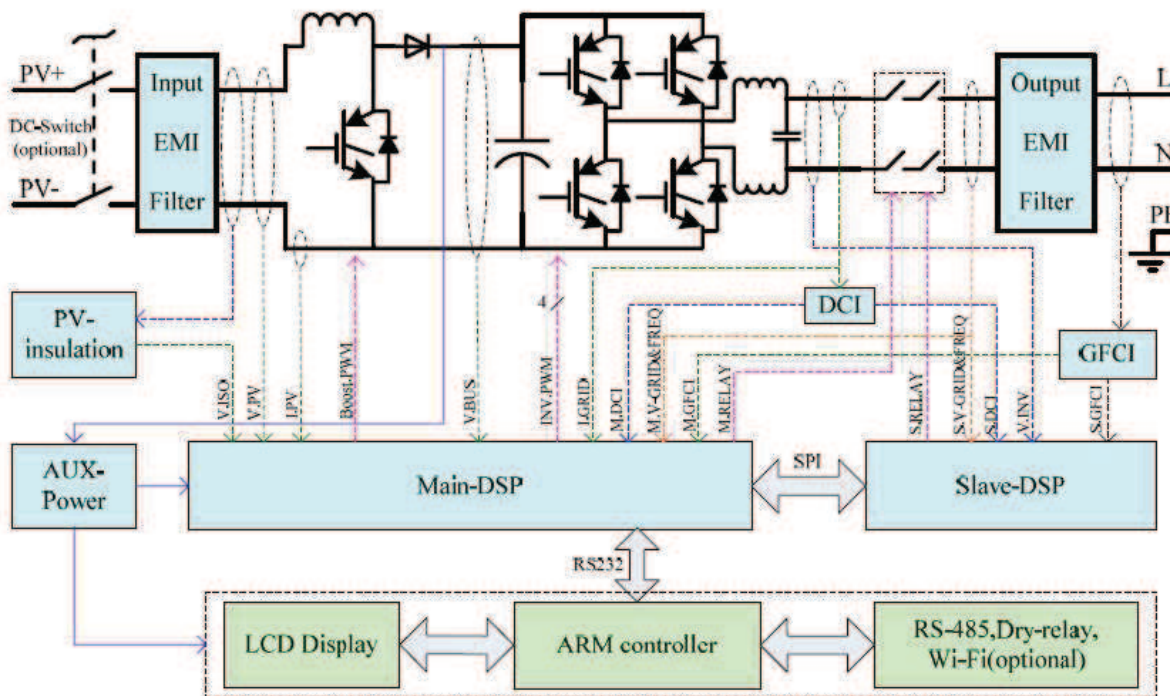

The internal control is redundant built. It consists of Microcontroller Master DSP (UC34) and Slave DSP (UC35).

The Master DSP control the relays (RYP2-RYP5) by switching signals; measures the PV voltage, PV current, Bus voltage, grid voltage, frequency, AC current with injected DC and the array insulation resistance to ground. In addition it tests the current sensors and the RCMU circuit before each start up.

The Slave DSP (UC35) is measures the grid voltage, AC current, grid frequency and residual current, also can switch off the relays (RYP2-RYP5) independently, and communicate with Master DSP (UC34) each other.

The current is measured by a current sensor. The AC current signal and the injected DC current signal are sent to the Master DSP(UC34). The Master DSP(UC34) tests and calibrates before each start up all current sensors.

The unit provides two relays in series in all output conductors. When single fault applied to one relay, alarm an error code in display panel, another redundant relay provides basic insulation maintained between the PV array and the mains. All the relays are tested before each start up.

The product was tested on:

Hardware version: V1.00

Software version: V1.00

<b>ABNT NBR 16150 "Sistemas fotovoltaicos (FV) – Características da interface de conexão com a rede elétrica de distribuição – Procedimento de ensaio de conformidade"</b>			
<b>Clause</b>	<b>Requirement – Test</b>	<b>Result – Remark</b>	<b>Verdict</b>
<b>SECTION 6: Test procedure</b>			
<b>6.1</b>	<p><b>Flicker</b> The compliance test procedure relating to flicker is included in IEC 61000-3-3 (for systems with current less than 16 A), IEC 61000-3-11 (for systems with current greater than 16 A and less than 75 A) and IEC 61000-3-5 (for systems with current greater than 75 A). The EUT is deemed compliant if the flicker values measured do not exceed the limits of the standards mentioned in 6.1.</p>	See appended table.	<b>P</b>
<b>6.2</b>	<p><b>DC-Injection</b> The manufacturer of the EUT is fully responsible for providing a way of shifting the output current (producing direct current component injection). The EUT is deemed compliant if the disconnection times measured following the direct current component injection do not exceed the limits set out in ABNT NBR 16149.</p>	See appended table.	<b>P</b>
<b>6.3</b>	<p><b>Harmonics</b> The EUT is deemed compliant if the THDi values measured do not exceed the limits set out in ABNT NBR 16149.</p>	See appended table.	<b>P</b>
<b>6.4</b>	<p><b>Power factor</b> The EUT is deemed compliant if the difference between the power factor values measured and the values expected is within a tolerance of <math>\pm 0.025</math>. The EUT is deemed compliant if the difference between the power factor values measured and the values expected (standard curve) is within a tolerance of <math>\pm 0.025</math>.</p>	See appended table.	<b>P</b>
<b>6.5</b>	<p><b>Reactive power injection/demand</b> The EUT is deemed compliant if the difference between the reactive power values measured and the values expected is within a tolerance of <math>\pm 2.5\%</math> of the rated power of the EUT.</p>	See appended table.	<b>P</b>
<b>6.6</b>	<p><b>Over and under voltage</b> The EUT is deemed compliant if the overvoltage disconnection voltage does not exceed the limits set out ABNT NBR 16149, with a tolerance of <math>\pm 2\%</math>. The EUT is deemed compliant if the overvoltage disconnection time does not exceed the limits set out in ABNT NBR 16149, with a tolerance of <math>\pm 2\%</math>. The EUT is deemed compliant if the undervoltage disconnection voltage does not exceed the limits set out in ABNT NBR 16149, with a tolerance of <math>\pm 2\%</math>. The EUT is deemed compliant if the undervoltage disconnection time does not exceed the limits set out in ABNT NBR 16149, with a tolerance of <math>\pm 2\%</math>.</p>	See appended table.	<b>P</b>

6.7	<p><b>Over and under frequency</b> The EUT is deemed compliant if the overfrequency disconnection frequency does not exceed the limits set out in ABNT NBR 16149, with a tolerance of <math>\pm 0.1</math> Hz. The EUT is deemed compliant if the overfrequency disconnection time does not exceed the limits set out in ABNT NBR 16149, with a tolerance of <math>\pm 2\%</math>. The EUT is deemed compliant if the underfrequency disconnection frequency does not exceed the limits set out in ABNT NBR 16149, with a tolerance of <math>\pm 0.1</math> Hz. The EUT is deemed compliant if the underfrequency disconnection time does not exceed the limits set out in ABNT NBR 16149, with a tolerance of <math>\pm 2\%</math>.</p>	See appended table.	<b>P</b>
6.8	<p><b>Active power control at over frequency</b> The EUT is deemed compliant if it meets the following requirements: a) The difference between the active power values measured and the values expected is within a tolerance of <math>\pm 2.5\%</math> of the rated power of the EUT. b) The time required for the EUT to start increasing the active power injected, after the grid frequency has been reduced, is greater than or equal to the threshold set in ABNT NBR 16149. c) The gradient of the increase in active power injected is below the limit set in ABNT NBR 16149.</p>	See appended table.	<b>P</b>
6.9	<p><b>Reconnection</b> This test shall be performed during tests 6.6.1, 6.6.3, 6.7.1 and 6.7.3. Immediately after the rated voltage/frequency conditions have been restored, measure and record the time elapsed before reconnection. NOTE The reconnection time may be measured using a stop-watch.  The EUT is deemed compliant if the reconnection time does not exceed the limits set out in ABNT NBR 16149.</p>	See appended table.	<b>P</b>
6.10	<p><b>Automatic restart out of phase</b> NOTE The protection devices on the EUT might be activated by the application of the phase angle shift, in which case the fuses will have to be replaced.  The EUT is deemed compliant if it is not damaged during the performance of the test.</p>	See appended table.	<b>P</b>
6.11	<p><b>Active power modulation</b> The EUT is deemed compliant if the difference between the power values measured and the values expected is within a tolerance of <math>\pm 2.5\%</math> of the rated power of the EUT.</p>	Considered.	<b>P</b>
6.12	<p><b>Reactive power modulation</b> The EUT is deemed compliant if the difference between the power values measured and the values expected is within a tolerance of <math>\pm 2.5\%</math> of the rated power of the EUT.</p>	See appended table.	<b>P</b>
6.13	<p><b>Network disconnection of the PV system</b> The EUT is deemed compliant if it disconnects from the grid following the external disconnection command.</p>	See appended table.	<b>P</b>
6.14	<p><b>Low Voltage Fault Ride Through (LVFRT)</b> The EUT is deemed compliant if it meets the Low Voltage Fault Ride Through (LVFRT) requirements set out in ABNT NBR 16149.</p>	The EUT is used in less than 100kW systems.	<b>N/A</b>



## Test Results

1 Response to protection operation - fault condition tests (DIN V VDE V 0126-1-1:2006 Functional safety)								P
	ambient temperature [°C]:	24,8						—
	model/type of power supply:	DC : 62150H-1000S AC : 61512						—
	manufacturer of power supply:	Chroma						—
	rated markings of power supply:	DC: 0-1000V, 15kW AC: 0-300V, 18kW						—
component No.	fault	test condition		test time	fuse No.	fault condition		result
		AC	DC			AC	DC	
PV voltage detect UC1C Pin 9	Open	220V 13,18 A	450V 6,62A	2 Min.	--	220V 0,17A	450V 0,02A	PV inverter disconnected from grid immediately, error message: ID09. (PV voltage over range)
PV current detect UC1B Pin 5	Open	220V 13,18 A	450V 6,62A	2 Min.	--	220V 0,17A	450V 0,02A	PV inverter disconnected from grid immediately, error message: ID14. (PV current over range)
GFCI detect UC2D Pin 12-13	Short	220V 13,18 A	450V 6,62A	2 Min.	--	220V 0,17A	450V 0,02A	PV inverter disconnected from grid immediately, error message: ID12. (GFCI fault)
GFCI detect UC2C Pin 10	Short	220V 13,18 A	450V 6,62A	2 Min.	--	220V 0,17A	450V 0,02A	PV inverter disconnected from grid immediately, error message: ID52. (GFCI fault)
Grid voltage detect UC2A Pin 3	Open	220V 13,18 A	450V 6,62A	2 Min.	--	220V 0,17A	450V 0,02A	PV inverter disconnected from grid immediately, error message: ID15. (Grid current or voltage over range)
Grid voltage detect RC17	Open	220V 13,18 A	450V 6,62A	2 Min.	--	220V 0,17A	450V 0,02A	PV inverter disconnected from grid immediately, error message: ID02, ID49, ID70. (Grid current or voltage under range)
Grid voltage detect RC25	Open	220V 13,18 A	450V 6,62A	2 Min.	--	220V 0,17A	450V 0,02A	PV inverter disconnected from grid immediately, error message: ID55. (Relay fault)
Bus voltage detect RP3	Open	220V 13,18 A	450V 6,62A	2 Min.	--	220V 0,17A	450V 0,02A	PV inverter disconnected from grid immediately, error message: ID23. (Bus voltage zero fault)

component No.	fault	test condition		test time	fuse No.	fault condition		result
		AC	DC			AC	DC	
Bus voltage detect UC1A Pin2-3	Short	220V 13,18 A	450V 6,62A	2 Min.	--	220V 0,17A	450V 0,02A	PV inverter disconnected from grid immediately, error message: ID66. (Bus voltage over range)
Bus voltage detect RC82	Short	220V 13,18 A	450V 6,62A	2 Min.	--	220V 0,17A	450V 0,02A	PV inverter disconnected from grid immediately, error message: ID25. (Bus voltage under range)
ISO detect RC105	Open before start	220V 0,17A	450V 0,02A	2 Min.	--	220V 0,17A	450V 0,02A	PV inverter can not start up, error message: ID56. (ISO fault)
AC current detect RC22	Open	220V 13,18 A	450V 6,62A	2 Min.	--	220V 0,17A	450V 0,02A	PV inverter disconnected from grid immediately, error message: ID15. (AC current over range), QP2, QP6, QP9, RP26, RP28, RP11 damaged.
AC current detect RC21	Open	220V 13,18 A	450V 6,62A	2 Min.	--	220V 0,17A	450V 0,02A	PV inverter disconnected from grid immediately, error message: ID15. (AC current over range).
DC current detect RC33	Open	220V 13,18 A	450V 6,62A	2 Min.	--	220V 0,17A	450V 0,02A	PV inverter disconnected from grid immediately, error message: ID28. (DC current over range).
DC current detect RC37	Open	220V 13,18 A	450V 6,62A	2 Min.	--	220V 0,17A	450V 0,02A	PV inverter disconnected from grid immediately, error message: ID28. (DC current over range).
DC current detect RC42	Open	220V 13,18 A	450V 6,62A	2 Min.	--	220V 0,17A	450V 0,02A	PV inverter disconnected from grid immediately, error message: ID51. (DC current fault).
AC current detect RC61	Open	220V 13,18 A	450V 6,62A	2 Min.	--	220V 0,17A	450V 0,02A	PV inverter disconnected from grid immediately, error message: ID15, ID65. (AC voltage or current over range).
AC current detect RC80	Open	220V 13,18 A	450V 6,62A	2 Min.	--	220V 0,17A	450V 0,02A	PV inverter disconnected from grid immediately, error message: ID15, ID65. (AC voltage or current over range).
GFCI detect RP70	Open	220V 13,18 A	450V 6,62A	2 Min.	--	220V 0,17A	450V 0,02A	PV inverter disconnected from grid immediately, error message: ID12. (GFCI fault).
GFCI detect RP80	Open	220V 13,18 A	450V 6,62A	2 Min.	--	220V 0,17A	450V 0,02A	PV inverter disconnected from grid immediately, error message: ID12. (GFCI fault).

component No.	fault	test condition		test time	fuse No.	fault condition		result
		AC	DC			AC	DC	
GFCI detect UP7A Pin2-3	Short	220V 13,18 A	450V 6,62A	2 Min.	--	220V 0,17A	450V 0,02A	PV inverter disconnected from grid immediately, error message: ID12. (GFCI fault).
PV voltage detect RP115	Open	220V 13,18 A	450V 6,62A	2 Min.	--	220V 0,17A	450V 0,02A	PV inverter disconnected from grid immediately, no display, and reconnect to grid, error message: ID56. (ISO fault).
PV voltage detect RP115	Short	220V 13,18 A	450V 6,62A	2 Min.	--	220V 0,17A	450V 0,02A	PV inverter disconnected from grid immediately, error message: ID09. (PV voltage over range)
ISO detect RP99	Open before start	220V 0,17A	450V 0,02A	2 Min.	--	220V 0,17A	450V 0,02A	PV inverter can not start up, error message: ID56. (ISO fault).
Relay detect RYP2 Pin3-4	Short before start	220V 0,17A	450V 0,02A	2 Min.	--	220V 0,17A	450V 0,02A	PV inverter can not start up, error message: ID55, ID77. (Relay fault).
Relay detect RYP3 Pin3-4	Short before start	220V 0,17A	450V 0,02A	2 Min.	--	220V 0,17A	450V 0,02A	PV inverter can not start up, error message: ID55, ID77. (Relay fault).
Relay detect RYP4 Pin3-4	Short before start	220V 0,17A	450V 0,02A	2 Min.	--	220V 0,17A	450V 0,02A	PV inverter can not start up, error message: ID55, ID77. (Relay fault).
Relay detect RYP5 Pin3-4	Short before start	220V 0,17A	450V 0,02A	2 Min.	--	220V 0,17A	450V 0,02A	PV inverter can not start up, error message: ID55, ID77. (Relay fault).
Grid voltage detect RP150	Open	220V 13,18 A	450V 6,62A	2 Min.	--	220V 0,17A	450V 0,02A	PV inverter disconnected from grid immediately, error message: ID02. (Grid voltage under range)
Grid voltage detect RP150	Short	220V 13,18 A	450V 6,62A	2 Min.	--	220V 0,17A	450V 0,02A	PV inverter disconnected from grid immediately, error message: ID01. (Grid voltage over range)
Grid voltage detect RP135	Short	220V 13,18 A	450V 6,62A	2 Min.	--	220V 0,17A	450V 0,02A	PV inverter disconnected from grid immediately, error message: ID01. (Grid voltage over range)
Grid voltage detect RP135	Open	220V 13,18 A	450V 6,62A	2 Min.	--	220V 0,17A	450V 0,02A	PV inverter disconnected from grid immediately, error message: ID02. (Grid voltage under range)
Loss of control CC100	Short	220V 13,18 A	450V 6,62A	2 Min.	--	220V 0,17A	450V 0,02A	PV inverter disconnected from grid immediately, error message: DSP communicate fail
Loss of control XLC	Short	220V 13,18 A	450V 6,62A	2 Min.	--	220V 0,17A	450V 0,02A	PV inverter disconnected from grid immediately, error message: DSP communicate fail

component No.	fault	test condition		test time	fuse No.	fault condition		result
		AC	DC			AC	DC	
Communication microcontroller defect UC34 Pin 31	Open	220V 13,18 A	450V 6,62A	2 Min.	--	220V 0,17A	450V 0,02A	PV inverter disconnected from grid immediately, error message: ID 53 (SPI Communication fault)
Communication microcontroller defect UC34 Pin 37	Open	220V 13,18 A	450V 6,62A	2 Min.	--	220V 0,17A	450V 0,02A	PV inverter disconnected from grid immediately, error message: ID 53 (SPI Communication fault)
Communication microcontroller defect UC34 Pin 44	Open	220V 13,18 A	450V 6,62A	2 Min.	--	220V 0,17A	450V 0,02A	PV inverter disconnected from grid immediately, error message: ID 53 (SPI Communication fault)
Communication microcontroller defect UC34 Pin 47	Open	220V 13,18 A	450V 6,62A	2 Min.	--	220V 0,17A	450V 0,02A	PV inverter disconnected from grid immediately, error message: ID 53 (SPI Communication fault)

**Note:**

The errors in the control circuit simulate that the safety is even under one error ensured.

6.1 Flicker				P
<b>Test conditions:</b>	Maximum permissible voltage fluctuation (expressed as a percentage of nominal voltage at 100 % power) and flicker as per EN 61000-3-3			
	<b>Starting</b>	<b>Stopping</b>	<b>Running</b>	
<b>Limit</b>	3,3%	3,3%	$P_{st}=1,0$	$P_{it}=0,65$
<b>Test value</b>	*	*	*	*
<b>inverter &lt;=16A</b>				
<b>Limit</b>	dc% = 3,3		$P_{st}=1,0$	$P_{it}=0,65$
<b>Test value</b>	0,07		0,14	0,13
<p>Note:            *The stationary deviance of dc% is more relevant than the dynamic deviance of <math>d_{max}</math> at starting and stopping.</p> <p>Mains Impedance according EN 61000-3-3: <math>R_{max} = 0,24\Omega</math>; <math>jX_{max} = 0,15\Omega @50Hz</math> (<math> Z_{max}  = 0,283/0,472\Omega</math>)  <b>for single phase inverter use also <math>R_n = 0,16\Omega</math>; <math>jX_n = 0,1\Omega</math></b></p> <p>Calculation of the maximum permissible grid impedance at the point of common coupling based on <math>d_c</math>:  <math>Z_{max} = Z_{ref} * 3,3\% / d_c(P_n)</math>            The tests should be based on the limits of the EN61000-3-3 for less than 16A.</p>				

<b>6.2 DC-Injection</b>	<b>P</b>
-------------------------	----------

**Permanent DC component in AC output**

Test result:

Power Level	(33 ± 5)%	(66 ± 5)%	(100 ± 5)%
	<b>(Phase1)</b>		
Watt	1002	1992	3015
Vrms	220,54	220,80	220,66
Arms	4,558	9,032	13,672
PF	0,9967	0,9989	0,9993
Cosφ	0,9967	0,9989	0,9993
DC (mA)	-61,58	-55,46	-49,31
DC (%)	-0,45	-0,41	-0,36

**Note:**

**Diagram of permanent DC-Injection**

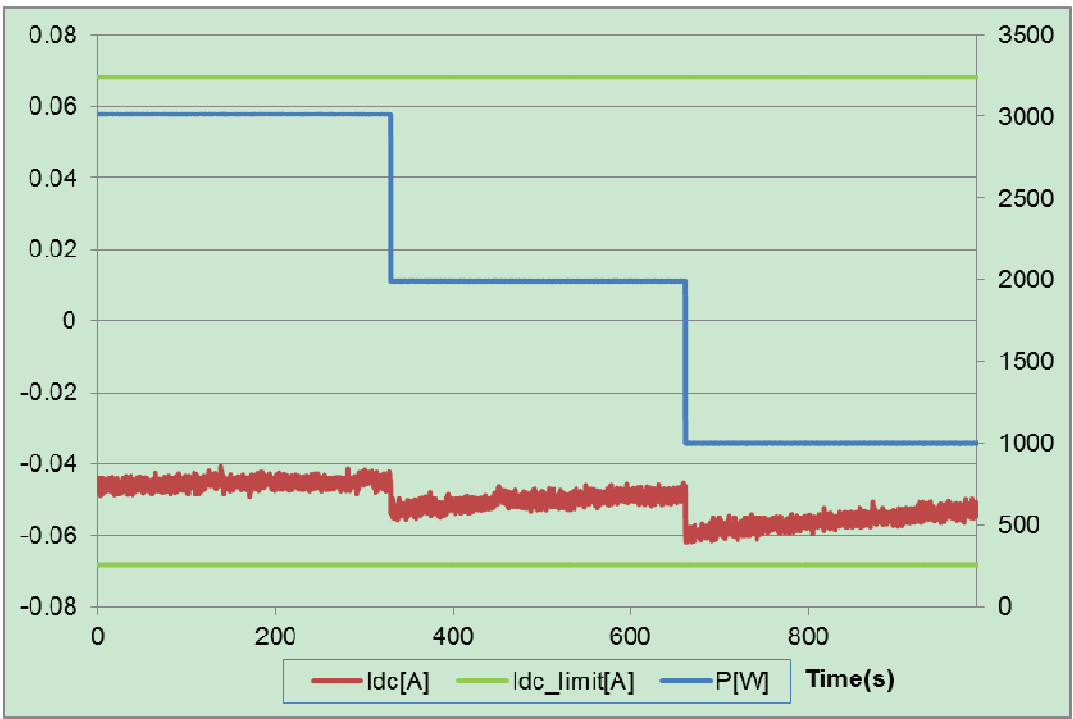

**Protection against DC component in AC output**

**Test result:**

Actual Power	Limits	Measurement: (mA)	Limiting value: (mA)	Disconnection time: (ms)
<b>Positive</b>				
33%	0,5%Inom/1s	72	68	920
66%	0,5%Inom/1s	72	68	920
100%	0,5%Inom/1s	72	68	875
<b>Negative</b>				
33%	0,5%Inom/1s	72	68	900
66%	0,5%Inom/1s	72	68	930
100%	0,5%Inom/1s	72	68	880

Positive:

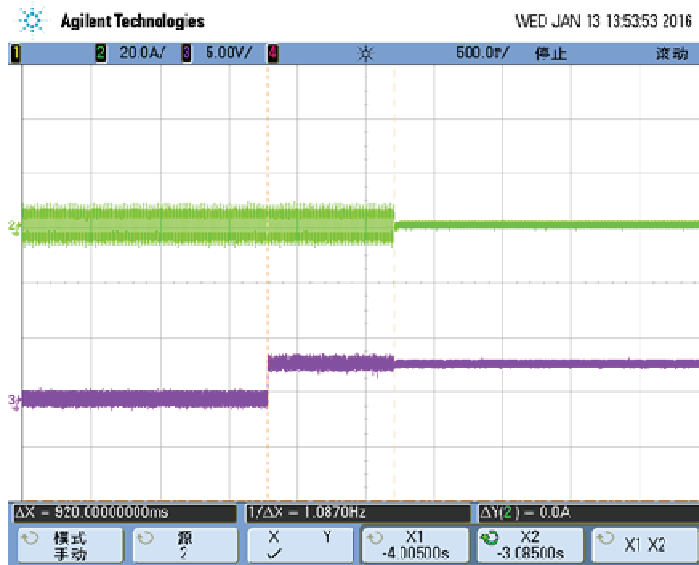

Negative:

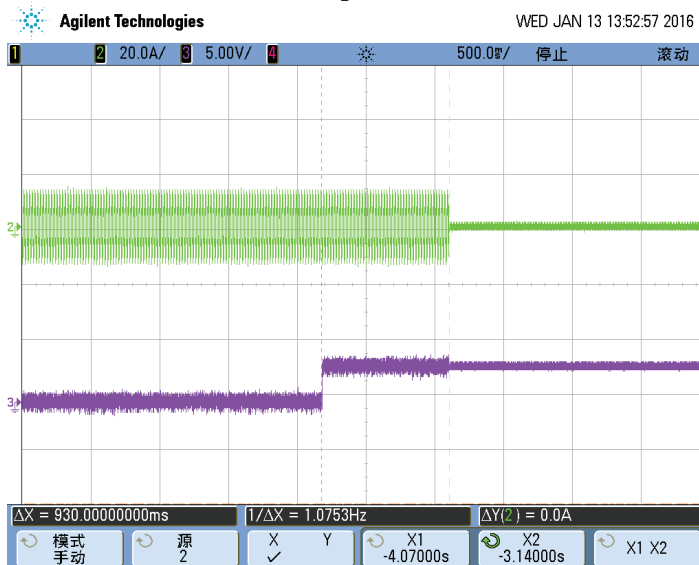

6.3 Harmonics				P
Output power 10%				
Watts		0,293 kW		
Vrms		220,3 V		
Arms		1,331 A		
Frequency		60,00 Hz		
THD (10% output power)		0,594 %		
Harmonics	Current Magnitude (A)	% of Rated Current	Phase	Harmonic Current Limits (%)
1st	1,331	9,757	Single Phase	-
2nd	0,004	0,032	Single Phase	1
3rd	0,072	0,527	Single Phase	4
4th	0,006	0,044	Single Phase	1
5th	0,028	0,207	Single Phase	4
6th	0,005	0,039	Single Phase	1
7th	0,016	0,117	Single Phase	4
8th	0,002	0,018	Single Phase	1
9th	0,010	0,073	Single Phase	4
10th	0,002	0,013	Single Phase	0,5
11th	0,006	0,043	Single Phase	2
12th	0,001	0,008	Single Phase	0,5
13th	0,003	0,023	Single Phase	2
14th	0,001	0,009	Single Phase	0,5
15th	0,004	0,030	Single Phase	2
16th	0,000	0,003	Single Phase	0,5
17th	0,005	0,036	Single Phase	1,5
18th	0,001	0,009	Single Phase	0,5
19th	0,001	0,007	Single Phase	1,5
20th	0,001	0,005	Single Phase	0,5
21th	0,001	0,009	Single Phase	1,5
22th	0,001	0,006	Single Phase	0,5
23th	0,003	0,020	Single Phase	0,6
24th	0,001	0,007	Single Phase	0,5
25th	0,002	0,014	Single Phase	0,6
26th	0,002	0,015	Single Phase	0,5
27th	0,000	0,003	Single Phase	0,6
28th	0,001	0,006	Single Phase	0,5
29th	0,001	0,005	Single Phase	0,6
30th	0,001	0,006	Single Phase	0,5
31th	0,002	0,012	Single Phase	0,6
32th	0,000	0,004	Single Phase	0,5
33th	0,002	0,015	Single Phase	0,6
34th	0,001	0,005	Single Phase	N/A
35th	0,001	0,007	Single Phase	N/A
36th	0,001	0,005	Single Phase	N/A
37th	0,001	0,011	Single Phase	N/A
38th	0,001	0,006	Single Phase	N/A
39th	0,002	0,015	Single Phase	N/A
40th	0,001	0,005	Single Phase	N/A



Output power 20%				
<b>Watts</b>			<b>0,607 kW</b>	
<b>Vrms</b>			<b>220,3 V</b>	
<b>Arms</b>			<b>2,755 A</b>	
<b>Frequency</b>			<b>60,00 Hz</b>	
<b>THD (20% output power)</b>			<b>0,659 %</b>	
<b>Harmonics</b>	<b>Current Magnitude (A)</b>	<b>% of Fundamental</b>	<b>Phase</b>	<b>Harmonic Current Limits (%)</b>
1st	2,755	20,206	Single Phase	-
2nd	0,002	0,018	Single Phase	1
3rd	0,082	0,601	Single Phase	4
4th	0,007	0,050	Single Phase	1
5th	0,031	0,228	Single Phase	4
6th	0,004	0,031	Single Phase	1
7th	0,014	0,100	Single Phase	4
8th	0,001	0,006	Single Phase	1
9th	0,007	0,049	Single Phase	4
10th	0,001	0,010	Single Phase	0,5
11th	0,004	0,029	Single Phase	2
12th	0,000	0,002	Single Phase	0,5
13th	0,003	0,021	Single Phase	2
14th	0,001	0,005	Single Phase	0,5
15th	0,003	0,021	Single Phase	2
16th	0,001	0,007	Single Phase	0,5
17th	0,003	0,019	Single Phase	1,5
18th	0,001	0,008	Single Phase	0,5
19th	0,003	0,018	Single Phase	1,5
20th	0,001	0,006	Single Phase	0,5
21th	0,002	0,014	Single Phase	1,5
22th	0,000	0,002	Single Phase	0,5
23th	0,002	0,015	Single Phase	0,6
24th	0,000	0,002	Single Phase	0,5
25th	0,001	0,009	Single Phase	0,6
26th	0,001	0,009	Single Phase	0,5
27th	0,002	0,011	Single Phase	0,6
28th	0,001	0,007	Single Phase	0,5
29th	0,001	0,009	Single Phase	0,6
30th	0,000	0,003	Single Phase	0,5
31th	0,002	0,013	Single Phase	0,6
32th	0,001	0,006	Single Phase	0,5
33th	0,001	0,006	Single Phase	0,6
34th	0,001	0,008	Single Phase	N/A
35th	0,001	0,004	Single Phase	N/A
36th	0,001	0,005	Single Phase	N/A
37th	0,001	0,004	Single Phase	N/A
38th	0,001	0,004	Single Phase	N/A
39th	0,000	0,002	Single Phase	N/A
40th	0,001	0,005	Single Phase	N/A

Output power 30%				
<b>Watts</b>		<b>0,920 kW</b>		
<b>Vrms</b>		<b>220,4 V</b>		
<b>Arms</b>		<b>4,174 A</b>		
<b>Frequency</b>		<b>60,00 Hz</b>		
<b>THD (30% output power)</b>		<b>0,749 %</b>		
<b>Harmonics</b>	<b>Current Magnitude (A)</b>	<b>% of Fundamental</b>	<b>Phase</b>	<b>Harmonic Current Limits (%)</b>
1st	4,170	30,579	Single Phase	-
2nd	0,003	0,020	Single Phase	1
3rd	0,093	0,680	Single Phase	4
4th	0,005	0,036	Single Phase	1
5th	0,033	0,240	Single Phase	4
6th	0,004	0,026	Single Phase	1
7th	0,013	0,092	Single Phase	4
8th	0,002	0,012	Single Phase	1
9th	0,007	0,048	Single Phase	4
10th	0,000	0,003	Single Phase	0,5
11th	0,005	0,037	Single Phase	2
12th	0,002	0,017	Single Phase	0,5
13th	0,006	0,046	Single Phase	2
14th	0,001	0,008	Single Phase	0,5
15th	0,007	0,052	Single Phase	2
16th	0,001	0,005	Single Phase	0,5
17th	0,008	0,056	Single Phase	1,5
18th	0,001	0,008	Single Phase	0,5
19th	0,009	0,063	Single Phase	1,5
20th	0,002	0,012	Single Phase	0,5
21th	0,007	0,051	Single Phase	1,5
22th	0,001	0,007	Single Phase	0,5
23th	0,007	0,051	Single Phase	0,6
24th	0,000	0,003	Single Phase	0,5
25th	0,006	0,044	Single Phase	0,6
26th	0,001	0,009	Single Phase	0,5
27th	0,006	0,044	Single Phase	0,6
28th	0,001	0,005	Single Phase	0,5
29th	0,004	0,033	Single Phase	0,6
30th	0,001	0,007	Single Phase	0,5
31th	0,004	0,031	Single Phase	0,6
32th	0,001	0,006	Single Phase	0,5
33th	0,003	0,025	Single Phase	0,6
34th	0,001	0,006	Single Phase	N/A
35th	0,003	0,022	Single Phase	N/A
36th	0,000	0,002	Single Phase	N/A
37th	0,003	0,019	Single Phase	N/A
38th	0,001	0,007	Single Phase	N/A
39th	0,002	0,018	Single Phase	N/A
40th	0,001	0,006	Single Phase	N/A

Output power 50%				
<b>Watts</b>		<b>1,517 kW</b>		
<b>Vrms</b>		<b>220,6 V</b>		
<b>Arms</b>		<b>6,878 A</b>		
<b>Frequency</b>		<b>60,00 Hz</b>		
<b>THD (50% output power)</b>		<b>0,871 %</b>		
<b>Harmonics</b>	<b>Current Magnitude (A)</b>	<b>% of Fundamental</b>	<b>Phase</b>	<b>Harmonic Current Limits (%)</b>
1st	6,882	50,472	Single Phase	-
2nd	0,002	0,017	Single Phase	1
3rd	0,104	0,764	Single Phase	4
4th	0,006	0,048	Single Phase	1
5th	0,031	0,228	Single Phase	4
6th	0,004	0,029	Single Phase	1
7th	0,012	0,087	Single Phase	4
8th	0,002	0,013	Single Phase	1
9th	0,009	0,069	Single Phase	4
10th	0,000	0,003	Single Phase	0,5
11th	0,012	0,089	Single Phase	2
12th	0,001	0,007	Single Phase	0,5
13th	0,015	0,109	Single Phase	2
14th	0,001	0,010	Single Phase	0,5
15th	0,016	0,114	Single Phase	2
16th	0,001	0,006	Single Phase	0,5
17th	0,015	0,113	Single Phase	1,5
18th	0,001	0,006	Single Phase	0,5
19th	0,015	0,113	Single Phase	1,5
20th	0,002	0,012	Single Phase	0,5
21th	0,014	0,102	Single Phase	1,5
22th	0,001	0,004	Single Phase	0,5
23th	0,013	0,092	Single Phase	0,6
24th	0,001	0,004	Single Phase	0,5
25th	0,012	0,086	Single Phase	0,6
26th	0,002	0,012	Single Phase	0,5
27th	0,010	0,072	Single Phase	0,6
28th	0,000	0,004	Single Phase	0,5
29th	0,009	0,065	Single Phase	0,6
30th	0,000	0,003	Single Phase	0,5
31th	0,007	0,053	Single Phase	0,6
32th	0,001	0,006	Single Phase	0,5
33th	0,007	0,048	Single Phase	0,6
34th	0,000	0,003	Single Phase	N/A
35th	0,005	0,040	Single Phase	N/A
36th	0,001	0,005	Single Phase	N/A
37th	0,005	0,037	Single Phase	N/A
38th	0,001	0,006	Single Phase	N/A
39th	0,004	0,031	Single Phase	N/A
40th	0,001	0,005	Single Phase	N/A

Output power 75%				
<b>Watts</b>		<b>2,265 kW</b>		
<b>Vrms</b>		<b>220,8 V</b>		
<b>Arms</b>		<b>10,259 A</b>		
<b>Frequency</b>		<b>60,00 Hz</b>		
<b>THD (75% output power)</b>		<b>1,025 %</b>		
<b>Harmonics</b>	<b>Current Magnitude (A)</b>	<b>% of Fundamental</b>	<b>Phase</b>	<b>Harmonic Current Limits (%)</b>
1st	10,264	75,272	Single Phase	-
2nd	0,003	0,020	Single Phase	1
3rd	0,124	0,912	Single Phase	4
4th	0,007	0,049	Single Phase	1
5th	0,027	0,200	Single Phase	4
6th	0,006	0,044	Single Phase	1
7th	0,012	0,088	Single Phase	4
8th	0,002	0,012	Single Phase	1
9th	0,014	0,104	Single Phase	4
10th	0,001	0,006	Single Phase	0,5
11th	0,018	0,129	Single Phase	2
12th	0,001	0,004	Single Phase	0,5
13th	0,019	0,141	Single Phase	2
14th	0,001	0,007	Single Phase	0,5
15th	0,020	0,149	Single Phase	2
16th	0,002	0,011	Single Phase	0,5
17th	0,020	0,144	Single Phase	1,5
18th	0,001	0,007	Single Phase	0,5
19th	0,019	0,139	Single Phase	1,5
20th	0,001	0,004	Single Phase	0,5
21th	0,017	0,127	Single Phase	1,5
22th	0,001	0,008	Single Phase	0,5
23th	0,015	0,112	Single Phase	0,6
24th	0,000	0,001	Single Phase	0,5
25th	0,013	0,095	Single Phase	0,6
26th	0,000	0,004	Single Phase	0,5
27th	0,011	0,079	Single Phase	0,6
28th	0,001	0,004	Single Phase	0,5
29th	0,009	0,064	Single Phase	0,6
30th	0,000	0,001	Single Phase	0,5
31th	0,007	0,055	Single Phase	0,6
32th	0,000	0,003	Single Phase	0,5
33th	0,006	0,045	Single Phase	0,6
34th	0,000	0,002	Single Phase	N/A
35th	0,005	0,036	Single Phase	N/A
36th	0,000	0,002	Single Phase	N/A
37th	0,004	0,030	Single Phase	N/A
38th	0,000	0,003	Single Phase	N/A
39th	0,004	0,027	Single Phase	N/A
40th	0,001	0,004	Single Phase	N/A

Output power 100%				
<b>Watts</b>		<b>3,016 kW</b>		
<b>Vrms</b>		<b>220,7 V</b>		
<b>Arms</b>		<b>22,705 A</b>		
<b>Frequency</b>		<b>60,00 Hz</b>		
<b>THD (100% output power)</b>		<b>1,195 %</b>		
<b>Harmonics</b>	<b>Current Magnitude (A)</b>	<b>% of Fundamental</b>	<b>Phase</b>	<b>Harmonic Current Limits (%)</b>
1st	13,676	100,290	Single Phase	-
2nd	0,004	0,031	Single Phase	1
3rd	0,146	1,074	Single Phase	4
4th	0,003	0,021	Single Phase	1
5th	0,020	0,145	Single Phase	4
6th	0,011	0,079	Single Phase	1
7th	0,009	0,070	Single Phase	4
8th	0,001	0,007	Single Phase	1
9th	0,018	0,132	Single Phase	4
10th	0,001	0,010	Single Phase	0,5
11th	0,026	0,189	Single Phase	2
12th	0,004	0,027	Single Phase	0,5
13th	0,020	0,149	Single Phase	2
14th	0,001	0,010	Single Phase	0,5
15th	0,024	0,176	Single Phase	2
16th	0,001	0,011	Single Phase	0,5
17th	0,026	0,192	Single Phase	1,5
18th	0,003	0,021	Single Phase	0,5
19th	0,020	0,149	Single Phase	1,5
20th	0,002	0,012	Single Phase	0,5
21th	0,018	0,132	Single Phase	1,5
22th	0,001	0,008	Single Phase	0,5
23th	0,018	0,134	Single Phase	0,6
24th	0,001	0,007	Single Phase	0,5
25th	0,015	0,108	Single Phase	0,6
26th	0,001	0,011	Single Phase	0,5
27th	0,012	0,085	Single Phase	0,6
28th	0,001	0,005	Single Phase	0,5
29th	0,010	0,076	Single Phase	0,6
30th	0,002	0,012	Single Phase	0,5
31th	0,009	0,063	Single Phase	0,6
32th	0,001	0,006	Single Phase	0,5
33th	0,006	0,047	Single Phase	0,6
34th	0,001	0,005	Single Phase	N/A
35th	0,006	0,042	Single Phase	N/A
36th	0,000	0,001	Single Phase	N/A
37th	0,005	0,035	Single Phase	N/A
38th	0,001	0,008	Single Phase	N/A
39th	0,003	0,024	Single Phase	N/A
40th	0,000	0,003	Single Phase	N/A

**Note:**  
The current total harmonic distortion shall be less than 5%, the rated power of the inverter. Each individual harmonic should be limited to the values shown in Table 1 of the ABNT NBR 16149. The even harmonics in these bands should be below 25% of the lower limits of the odd harmonics indicated.

6.4 Power factor				
6.4.1 Fixed power factor				P
Inductive reactive power absorption				
Power-BIN	Active power [W]	Reactive power [Var]	Power factor (cos $\phi$ )	DC power [W]
10%	319	-163	0,890	346
20%	612	-307	0,893	645
30%	915	-449	0,898	955
50%	1546	-748	0,900	1607
75%	2266	-1088	0,901	2354
100%	2744	-1317	0,902	2852
Capacitive reactive power supply				
Power-BIN	Active power [W]	Reactive power [Var]	Power factor (cos $\phi$ )	DC power [W]
10%	312	160	0,889	338
20%	599	295	0,897	630
30%	916	441	0,901	956
50%	1554	744	0,902	1613
75%	2268	1086	0,902	2354
100%	2783	1331	0,902	2889
<b>Note:</b>				
The photovoltaic system shall be capable of operating within the following power factor ranges when the active power injected into the grid is greater than 20% of the rated power of the inverter:				
<ul style="list-style-type: none"> <li>• photovoltaic systems with rated power less than or equal to 3 kW: factory-set PF equal to 1, but with capability of working within the 0.98 inductive to 0.98 capacitive range;</li> <li>• photovoltaic systems with rated power greater than 3 kW and less than or equal to 6 kW: PF adjustable from 0.95 inductive to 0.95 capacitive;</li> <li>• photovoltaic systems with rated power greater than 6 kW: PF adjustable from 0.90 inductive to 0.90 capacitive.</li> </ul>				

6.4.2 Power factor with standard curve					P
<b>Inductive reactive power absorption</b>					
Power-BIN	Active power P[W]	Reactive power Q[Var]	cosφ measured	cosφ expected	Δ cosφ
20%	615	75	0,9926	1,0	0,007
30%	930	81	0,9962	1,0	0,004
40%	1235	86	0,9976	1,0	0,002
50%	1538	90	0,9982	1,0	0,002
60%	1866	-319	0,9856	0,98	-0,006
70%	2148	-634	0,9591	0,96	0,001
80%	2430	-886	0,9395	0,94	0,000
90%	2730	-1086	0,9292	0,92	-0,009
100%	2798	-1123	0,9280	0,92	-0,008

**Note:**  
The EUT is deemed compliant if the difference between the power factor values measured and the values expected (standard curve) is within a tolerance of ± 0.025.

Following a change in active power, the photovoltaic system shall be capable of adjusting the reactive power output automatically so that it matches the PF set out above.  
Photovoltaic systems with rated power greater than 3 kW and less than or equal to 6 kW shall also be capable of controlling the power factor in accordance with a standard curve, as shown in Figure 1.

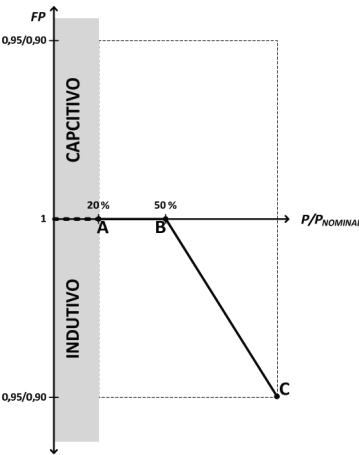

**Figura 1 – Curva padrão do FP em função da potência ativa de saída do inversor**

The standard curve shall only be enabled when the grid voltage exceeds the activation voltage, the value of which is adjustable between 100% and 110% of the rated grid voltage, with a factory-set standard value of 106%.

The standard curve shall only be disabled when the grid voltage falls to a value below the activation voltage. Any operational point resulting from the curve shall be reached within a maximum of 10 s.

Inverters for photovoltaic systems shall be distributed with the standard curve shown in Figure 1. Depending on the topology, grid load and power to be injected, the grid operator may provide a different standard curve, which shall be implemented in the inverters by means of the adjustment of points A, B and C in Figure 1.

The EUT is considered compliant if the difference between the values of power factor measured and expected values, is within the tolerance of ± 0.01.

The letter “i” is short for “inductive” and indicates inductive power factor. In case of capacitive power factor the letter “c” is used instead.

6.5 Reactive power demand / injection				P
<b>Inductive reactive power absorption</b>				
Power-BIN	Active power [W]	Reactive power [Var]	Power factor (cos φ)	DC power [W]
10%	292	-1484	0,1933	335
20%	598	-1480	0,3745	642
30%	910	-1494	0,5202	958
50%	1538	-1481	0,7204	1596
75%	2281	-1481	0,8387	2355
100%	2591	-1490	0,8669	2674
<b>Capacitive reactive power supply</b>				
Power-BIN	Active power [W]	Reactive power [Var]	Power factor (cos φ)	DC power [W]
10%	289	1480	0,1918	325
20%	591	1489	0,3688	629
30%	815	1502	0,4735	856
50%	1132	1513	0,5862	1179
75%	2138	1508	0,8107	2204
100%	2782	1509	0,8790	2865
<b>Reactive power supply with set point Q=0</b>				
Power-BIN	Active power [W]	Reactive power [Var]	Power factor (cos φ)	DC power [W]
10%	296	67	0,9743	315
20%	610	69	0,9932	634
30%	914	75	0,9966	943
50%	1529	85	0,9985	1571
75%	2273	99	0,9991	2333
100%	3026	122	0,9992	3107
<b>Note:</b>				
Photovoltaic systems with rated power greater than 6 kW shall also have a reactive power injection or demand capacity equal to 48.43% of the rated active power, as shown in Figure 2.				
The photovoltaic system can operate with two possibilities: (i) PF = 1 set at the factory to work with a tolerance in the range of 0.98 lagging to 0.98 leading. The inverter shall, as an option, the possibility to operate in accordance with the curve of Figure 1 and FP adjustable from 0.90 inductive to 0.90 capacitive, or (ii) control of reactive power (VAr), as Figure 2.				



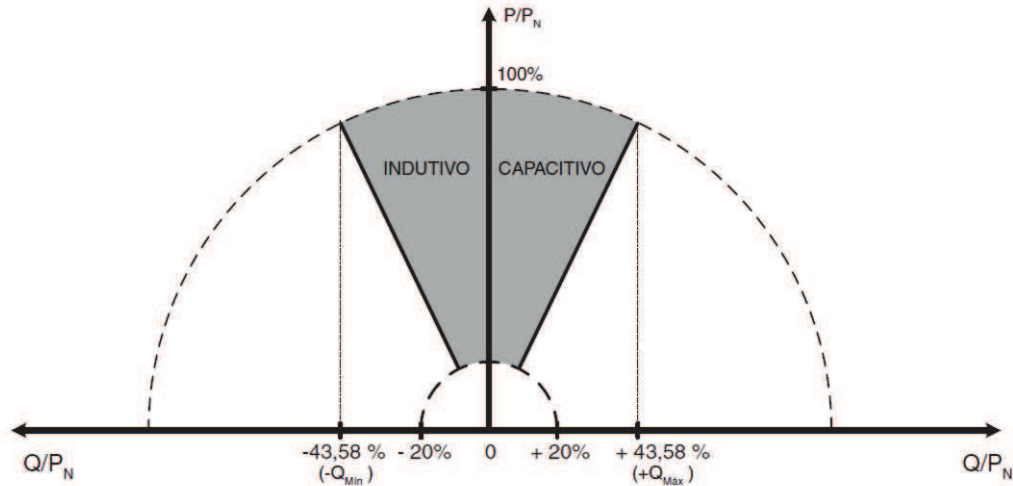

**Figura 2 – Limites operacionais de injeção/demanda de potência reativa para sistemas com potência nominal superior a 6 kW.**

The type and adjustments of PF control and reactive power injection/demand shall be determined by the grid conditions and established individually by the grid operator and supplied together with the access permission. The control types may be:

- fixed PF; or
- fixed reactive power; or
- standard curve for PF as a function of the active power output of the inverter or specific curve (adjustment of points A, B and C); or
- external control.

The inverter shall leave the factory with a PF of 1.

The EUT is considered compliant if the difference between the values of reactive power measured and expected values, is within the tolerance of  $\pm 2.5\%$  of rated output of the EUT.

6.6 Over / under voltage				P
<b>6.6.1 Measuring the voltage of overvoltage disconnection</b> <b>6.6.2 Measuring the disconnection time of overvoltage disconnection</b> <b>6.6.3 Measuring the voltage of undervoltage disconnection</b> <b>6.6.4 Measuring the disconnection time of undervoltage disconnection</b>				
phase voltage 220V				
<b>Test conditions:</b>	Output power: 100% Frequency: 60Hz			
	<b>Under Voltage</b>		<b>Over Voltage</b>	
		<b>Voltage [V]</b>		<b>Voltage [V]</b>
<b>Limit</b>		<b>176</b>		<b>242</b>
<b>Trip value</b>		175,9		241,9
		175,9		241,8
		175,8		241,8
		175,8		241,8
		175,9		241,9
<b>Parameter</b>		<b>Time [ms]</b>		<b>Time [ms]</b>
<b>Limit</b>		<b>&lt;= 400</b>		<b>&lt;= 200</b>
<b>Disconnection time</b>	193 V to 170 V	374	238 V to 246 V	191
		392		167
		375		182
		371		174
		381		169
<b>Reconnection time</b>	<b>20s to 300s</b>	70,2 s	<b>20s to 300s</b>	73,5 s
<b>Note:</b>				
The over and undervoltage trip values and disconnection times were measured according the test procedure 6.6, 6.6.1, 6.6.2, 6.6.3 and 6.6.4 in ABNT NBR 16150.				
The EUT is considered compliant if the voltage disconnect overvoltage does not exceed the limits in PN ABNT NBR 16149 with tolerance of $\pm 2\%$ .				
The EUT is considered compliant if the voltage disconnection undervoltage does not exceed the limits in PN ABNT NBR 16149, with a tolerance of $\pm 2\%$ .				
The EUT is considered in compliance if the time of disconnection overvoltage does not exceed the limits in ABNT NBR 16149 with tolerance of $\pm 2\%$ .				
The EUT is considered in compliance if the time of disconnection undervoltage does not exceed the limits in ABNT NBR 16149, with a tolerance of $\pm 2\%$ .				

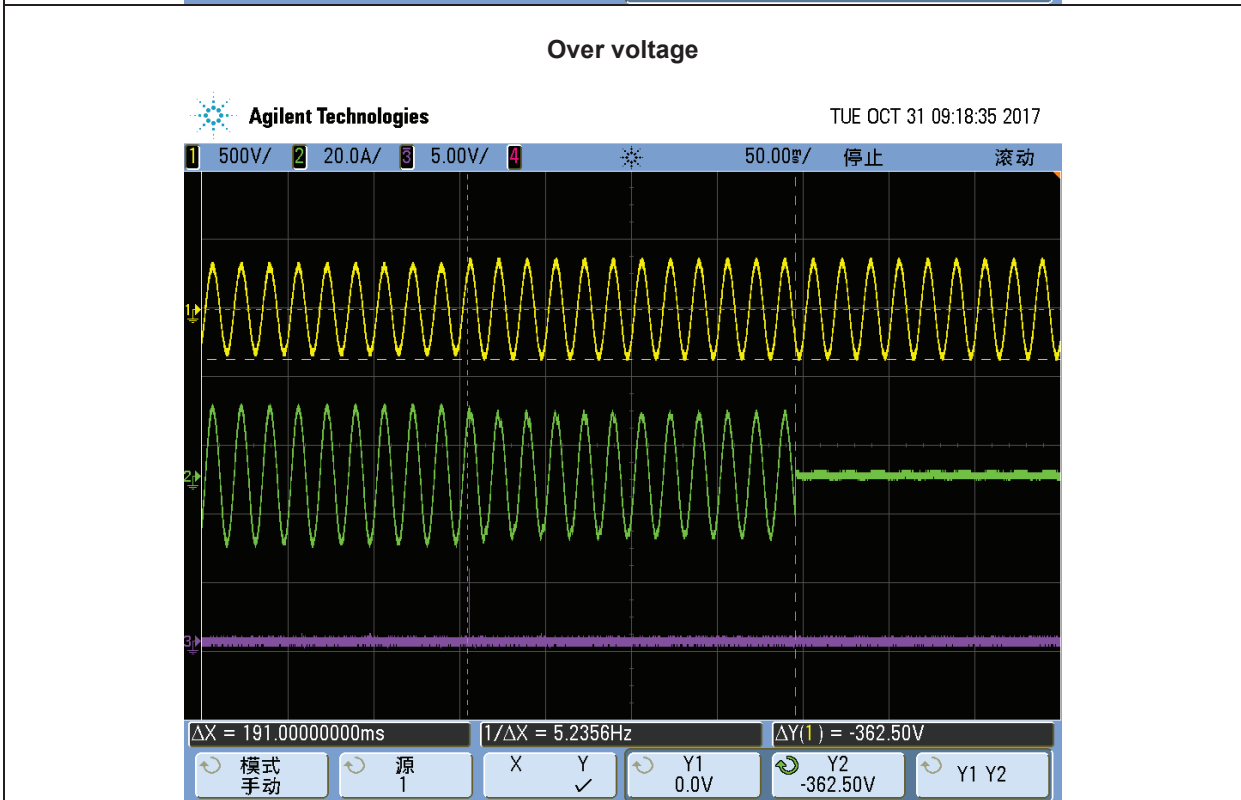
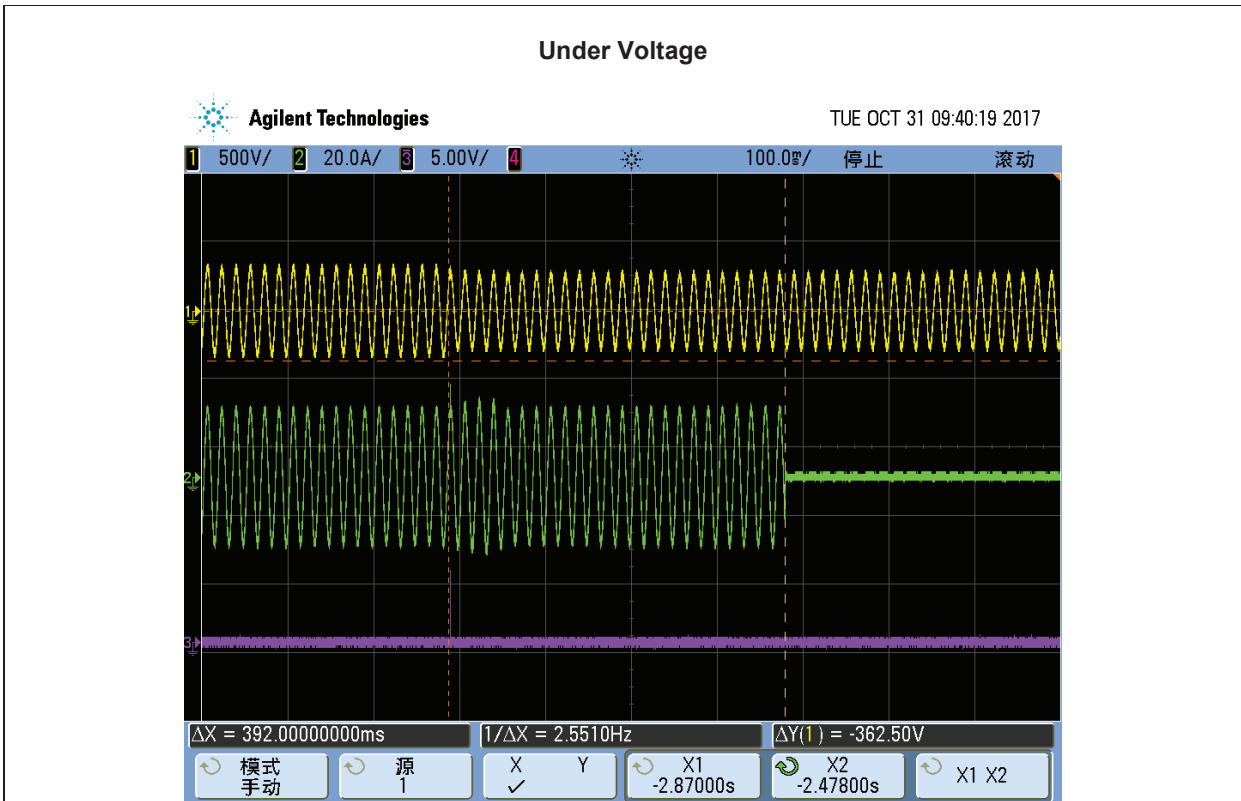

6.7 Over / under frequency				P
<b>6.7.1 Measuring the frequency of disconnection by overfrequency</b> <b>6.7.2 Measurement of disconnection time overfrequency</b> <b>6.7.3 Measuring the frequency of disconnection by underfrequency</b> <b>6.7.4 Measurement of disconnection time underfrequency</b>				
<b>Test conditions:</b>	Output power: 100%			
	<b>Under frequency</b>		<b>Over frequency</b>	
<b>Parameter</b>		<b>Frequency [Hz]</b>		<b>Frequency [Hz]</b>
<b>Output Voltage</b>		$U_N$		$U_N$
<b>Limit</b>		<b>57,50Hz</b>		<b>62,00Hz</b>
<b>Trip value</b>		57,50		62,10
		57,50		62,10
		57,50		62,10
		57,50		62,10
		57,50		62,10
		<b>Time [ms]</b>		<b>Time [ms]</b>
<b>Limit</b>		<b>&lt;= 200</b>		<b>&lt;= 200</b>
<b>Disconnection time</b>	58,00 Hz to 57,00 Hz	183	61,50 Hz to 62,50 Hz	169
		175		176
		175		177
		174		181
		181		175
<b>Reconnection time</b>	<b>20s to 300s</b>	72,9 s	<b>20s to 300s</b>	72,6 s
<b>Note:</b>				
<p>The over and undervoltage trip values and disconnection times were measured according the test procedure 6.7, 6.7.1, 6.7.2, 6.7.3 and 6.7.4 in ABNT NBR 16150.</p> <p>The EUT is considered compliant if the voltage disconnect overfrequency does not exceed the limits in PN ABNT NBR 16149 with tolerance of <math>\pm 2\%</math>.</p> <p>The EUT is considered compliant if the voltage disconnection underfrequency does not exceed the limits in PN ABNT NBR 16149, with a tolerance of <math>\pm 2\%</math>.</p> <p>The EUT is considered in compliance if the time of disconnection overfrequency does not exceed the limits in ABNT NBR 16149 with tolerance of <math>\pm 0,1\text{Hz}</math>.</p> <p>The EUT is considered in compliance if the time of disconnection underfrequency does not exceed the limits in ABNT NBR 16149, with a tolerance of <math>\pm 0,1\text{Hz}</math>.</p>				

### Under Frequency:

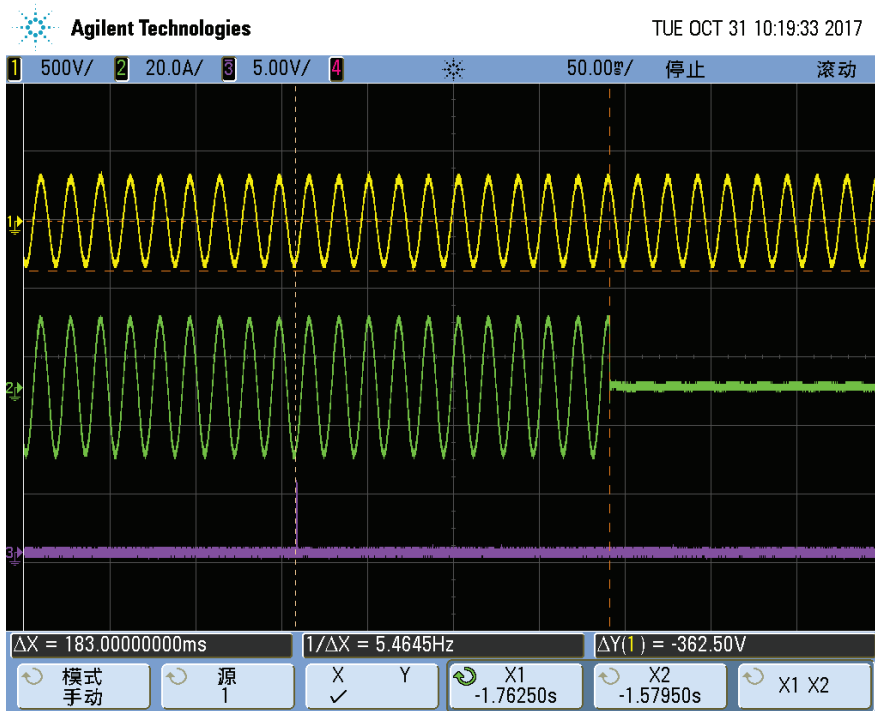

### Over Frequency:

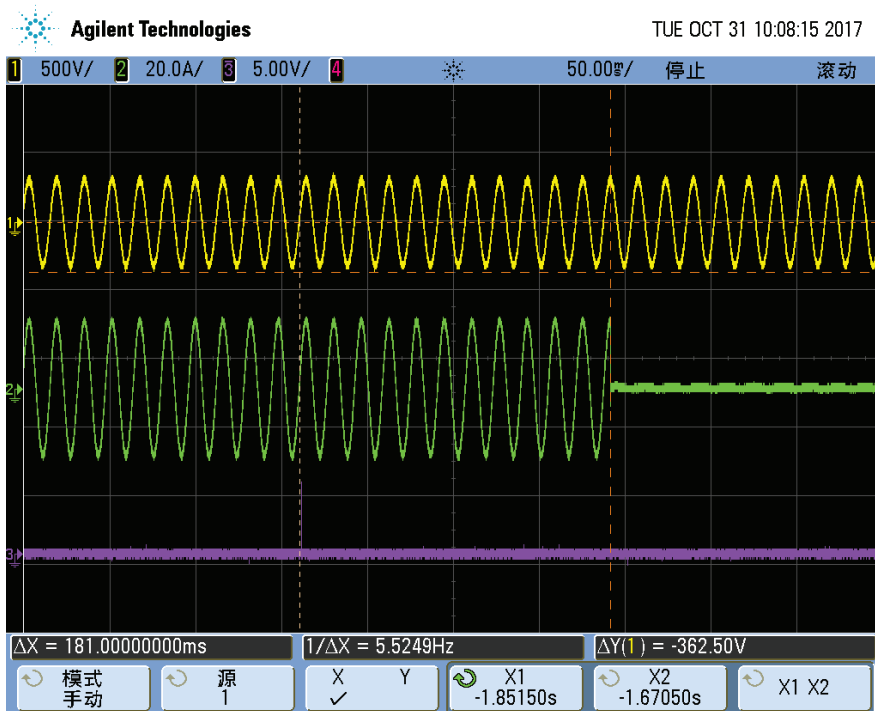

<b>6.8 Active power control at overfrequency</b>	<b>P</b>
--	----------

**Test:**

1-min mean value	c); d); e) 60,00Hz	f); g) 60,20Hz	h); i) 60,50Hz	j); k) 61,00Hz	l); m) 61,50Hz	n); o) 61,90Hz	p); q) 60,20Hz	r); s) 60,00Hz
------------------	-----------------------	-------------------	-------------------	-------------------	-------------------	-------------------	-------------------	-------------------

1. Measurement a) to s): Active power output 100%  $P_{E_{max}}$

Frequency [Hz]:	60,00	60,20	60,50	61,00	61,50	61,90	60,20	60,00
$P_{setpoint}$ [%]:	100,00	100,00	100,00	80,81	60,45	44,39	44,39	44,39
$P_{E30}$ [%]:	100,85	100,82	100,81	80,57	59,68	44,00	44,00	44,00
$\Delta P_{E30}/P_{Setpoint}$ [%]:	-0,85	-0,82	-0,81	0,24	0,77	0,39	0,39	0,39

2. Measurement a) to s): Active power output 50%  $P_{E_{max}}$

Frequency [Hz]:	60,00	60,20	60,50	61,00	61,50	61,90	60,20	60,00
$P_{setpoint}$ [%]:	50,00	50,00	50,00	40,46	30,23	22,26	22,26	22,26
$P_{E30}$ [%]:	50,56	50,55	50,54	40,49	28,50	21,97	21,97	21,98
$\Delta P_{E30}/P_{Setpoint}$ [%]:	-0,56	-0,55	-0,54	-0,03	0,73	0,29	0,28	0,28

**Limit**  
 $\Delta P_{E30}/P_{Setpoint}$ :  $\pm 2,5\%$  of  $P_{E_{max}}$

**Graph of Measurement 1.: Active power output reduction 100%  $P_{nom}$**

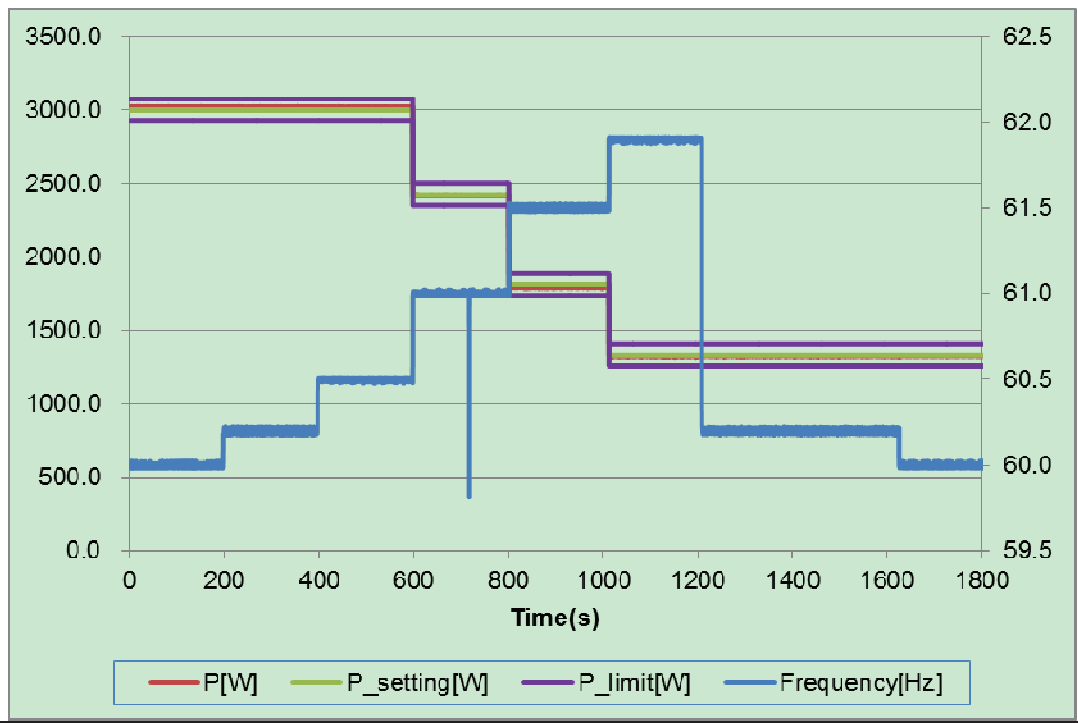

Graph of Measurement 2.: Active power output reduction 50%  $P_{nom}$

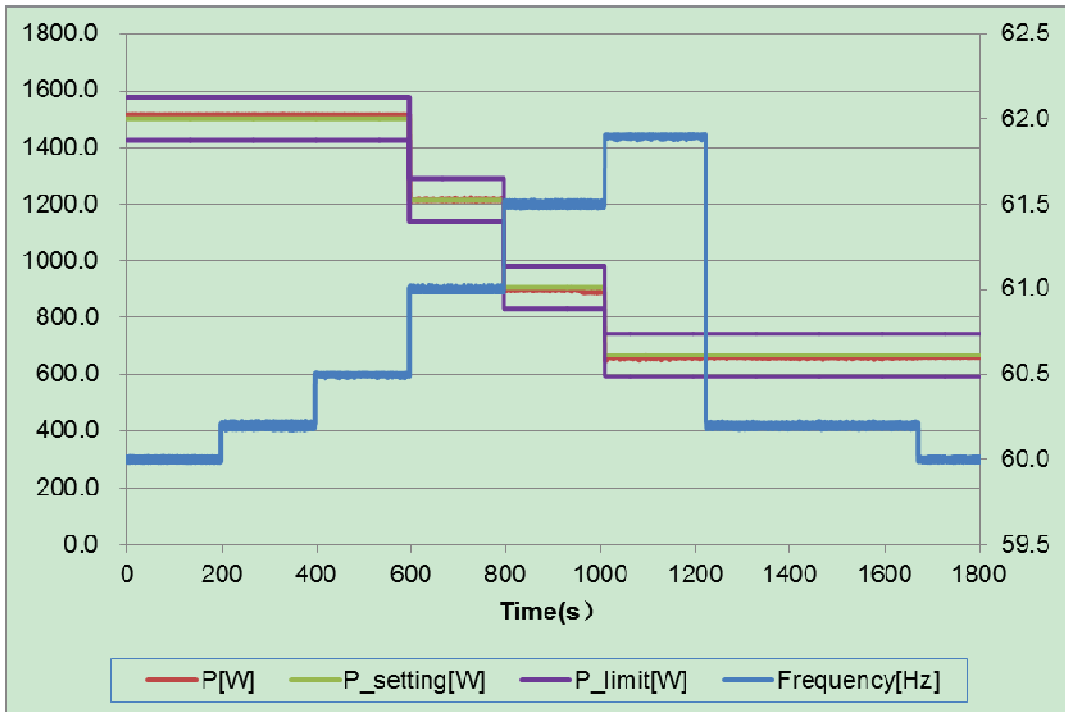

Graph of Measurement 2.: Power gradient 100%  $P_{nom}$

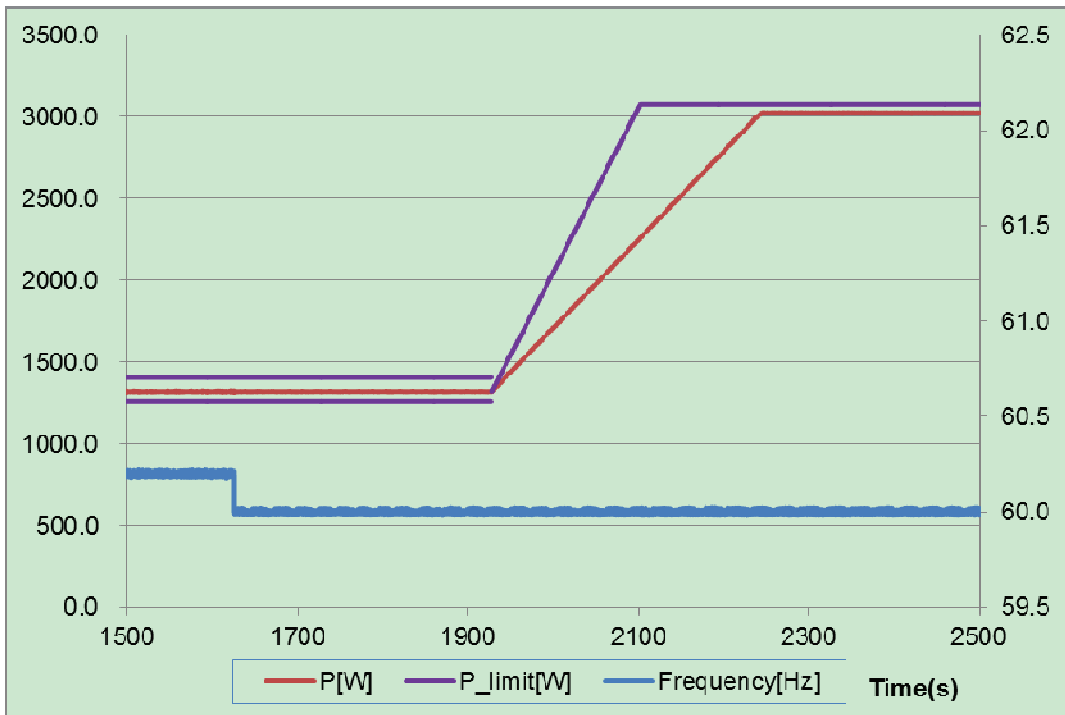

**Graph of Measurement 2.: Power gradient 50% P<sub>nom</sub>**

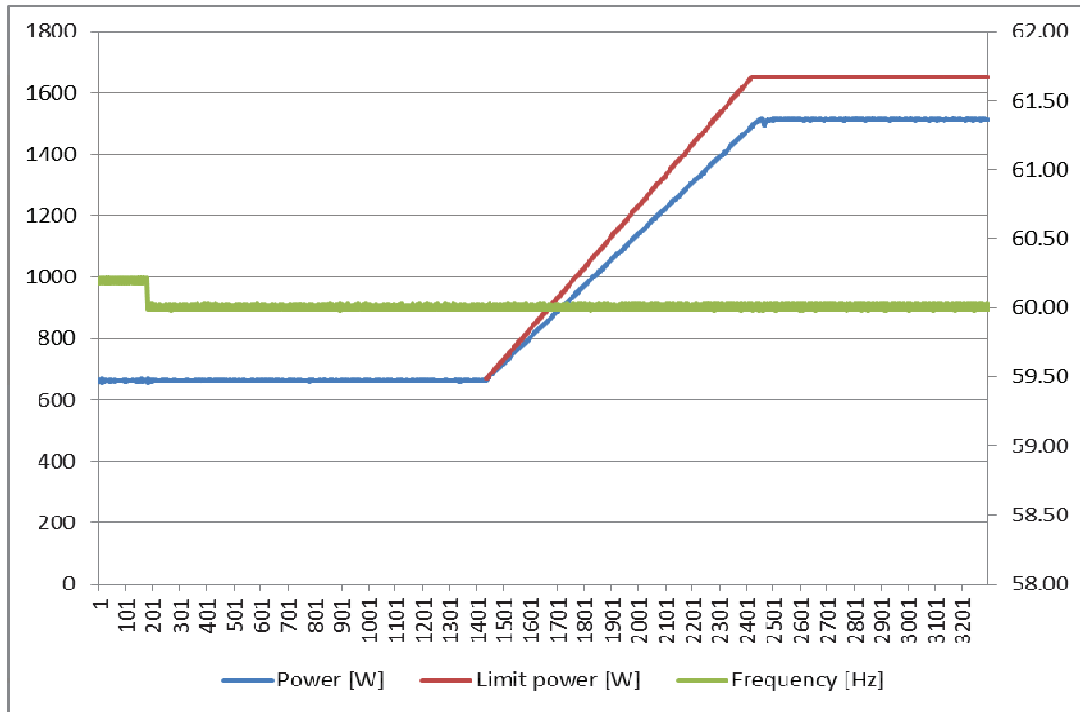

**Note:**

The frequency measurement resolution shall be  $\leq 0.01$  Hz.

When the grid frequency falls below 57.5 Hz, the photovoltaic system shall cease to supply energy to the grid within 0.2 s. The system shall only recommence supplying energy to the grid when the frequency returns to 59.9 Hz, in accordance with the reconnection time set out in 5.4. When the grid frequency exceeds 60.5 Hz and remains below 62 Hz, the photovoltaic system shall reduce the active power injected into the grid according to the following equation:

$$\Delta P = [f_{rede} - (f_{no\ min\ at} + 0,5)] \times R$$

where  $\Delta P$  is the variation in active power injected (as a %) in relation to the active power injected at the moment when the frequency rises above 60.5 Hz (PM),  $f_{grid}$  is the grid frequency,  $f_{rated}$  is the rated grid frequency and  $R$  is the desired rate of reduction in active power injected (as a %/Hz), adjusted to -40%/Hz.

If the grid frequency drops after the active power reduction process has begun, the photovoltaic system shall maintain the lowest active power value reached (PM - $\Delta P_{Max}$ .) during the frequency increase. The photovoltaic system shall only increase the active power injected when the grid frequency returns to the 60 Hz  $\pm$  0.05 Hz range for at least 300 s. The gradient of the increase in active power injected into the grid shall be less than 20% of PM per minute.

When the grid frequency exceeds 62 Hz, the photovoltaic system shall cease supplying energy to the grid. The system shall only recommence supplying energy to the grid when the frequency drops back to 60.1 Hz, in accordance with the reconnection time set out in 5.4. The gradient of the increase in active power injected into the grid shall be less than 20% of PM per minute.

Figure 3 shows the photovoltaic system operating curve as a function of grid frequency for disconnection due to overfrequency/underfrequency.



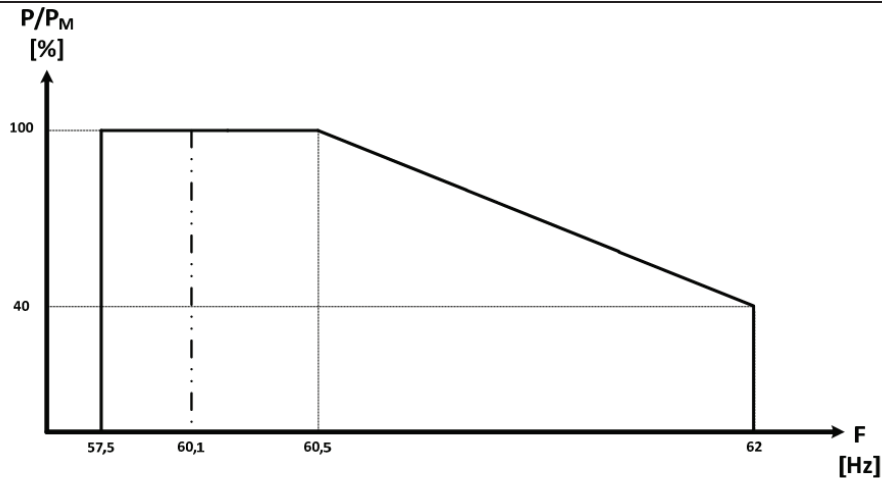

**Figura 3 – Curva de operação do sistema fotovoltaico em função da frequência da rede para a desconexão por sobre/subfrequência**

The EUT is deemed compliant if it meets the following requirements:

- The difference between the active power values measured and the values expected is within a tolerance of  $\pm 2.5\%$  of the rated power of the EUT.
- The time required for the EUT to start increasing the active power injected, after the grid frequency has been reduced, is greater than or equal to the threshold set in ABNT NBR 16149.
- The gradient of the increase in active power injected is below the limit set in ABNT NBR 16149.

<b>6.9 Reconnection</b>		<b>P</b>
This test must be performed during tests of 6.6.1, 6.6.3, 6.7.1, 6.7.3. Immediately after restore conditions nominal voltage / frequency, measure and record the elapsed time until reconnection.		
<b>Test:</b>		
	<b>Voltage conditons</b>	
a) Out of voltage range	79% U <sub>n</sub> for 600s	111% U <sub>n</sub> for 600s
Connection:	No connection	No connection
Limit	No connection allowed	
b) In voltage range at start-up	80% U <sub>n</sub> < U < 110% U <sub>n</sub>	
Reconnection time [s]	75,0	78,9
Limit:	Reconnection between 20s to 300s	
c) In voltage range after voltage failure	80% U <sub>n</sub> < U < 110% U <sub>n</sub>	
Reconnection time [s]	75,0	78,9
Limit:	Reconnection between 20s to 300s	
	<b>Frequency conditions</b>	
d) Out of frequency range	59,88Hz ± 0,01	60,12Hz ± 0,01
Connection:	No connection	No connection
Limit	No connection allowed	
e) In frequency range at start-up	59,90 Hz < f < 60,10	
Reconnection time [s]	78,9	79,8
Limit:	Reconnection between 20s to 300s	
f) In frequency range after frequency failure	59,90 Hz < f < 60,10	
Reconnection time [s]	78,9	79,8
Limit:	Reconnection between 20s to 300s	
<b>Test:</b> Test condition b) and c): voltage within the limits of 80% to 110% Test condition e) and f): frequency within the limits of 59,90Hz to 60,10Hz		
<b>Note:</b>		

<b>6.10 Automatic restart out of phase</b>	<b>P</b>
<p>This type of test must be performed as shown in Figure 2. The generator must not be damaged as a result of the tests. Protective devices may be switched off or released.</p> <p>With reference to ABNT NBR 16149 and ABNT NBR 16150: – Using the simulated network:</p> <ul style="list-style-type: none"><li>• The network simulator should be able to produce phase shifts in of the output voltage at the inverter terminals of 90° and 180°, respectively.</li><li>• Generator: inverter operating at nominal power with unity power factor (<math>\cos\phi= 1</math>)</li><li>• VR: simulated network voltage</li><li>• The generator must start operating at nominal power. Let the system operate under the conditions set for at least 5 minutes or the time needed to stabilise the internal temperature of the converter.</li></ul> <p>After the stabilisation period two tests should be performed in sequence, by inducing the transient that produces a phase shift angle on the simulated network voltage VR of 180° and 90°.</p> <p>In the test report the following data for each of the two test sequences shall be indicated:</p> <ul style="list-style-type: none"><li>• the angle between the voltage before and after the phase shift, with an instrument with a 1° error;</li><li>• the generator current on a time window starting from 20 ms before until at least 200 ms after the phase shift of the simulated network voltage.</li></ul>	
<p><b>Note:</b> The EUT is considered compliant if it is not damaged during testing.</p>	

Test results:

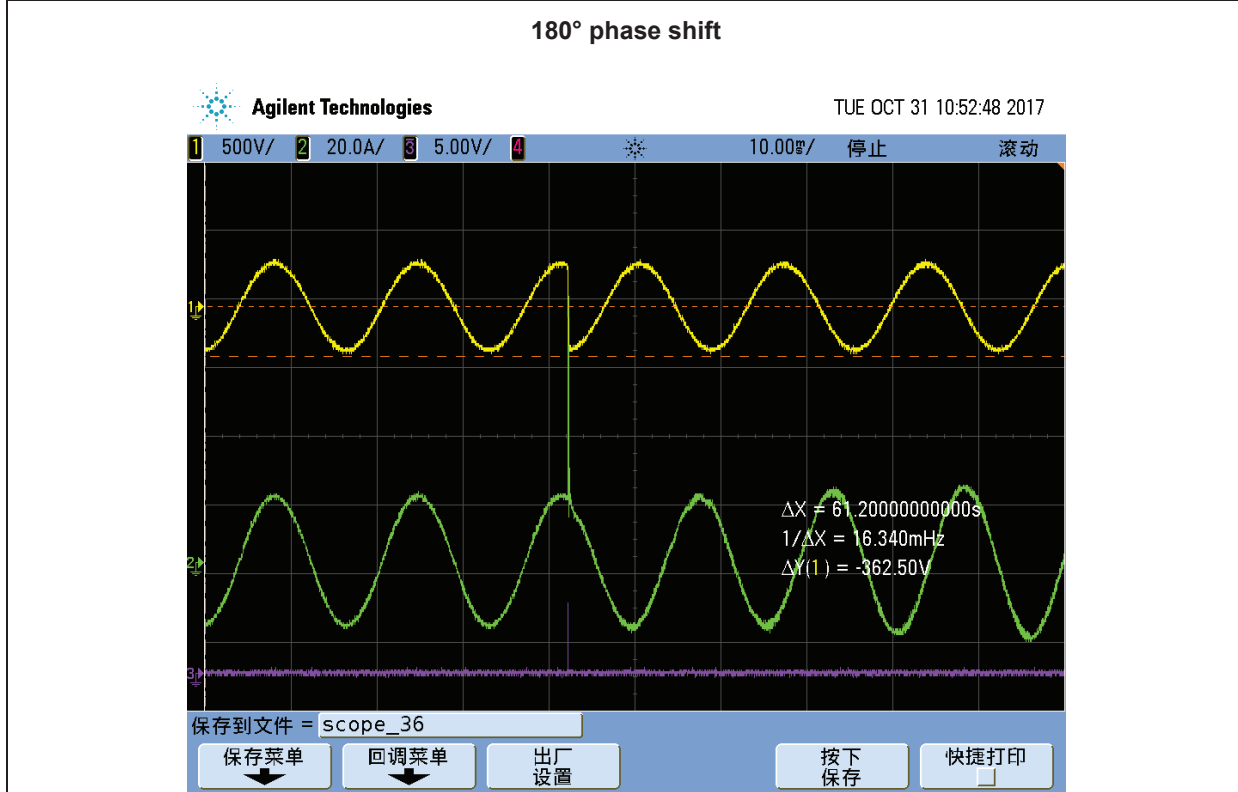
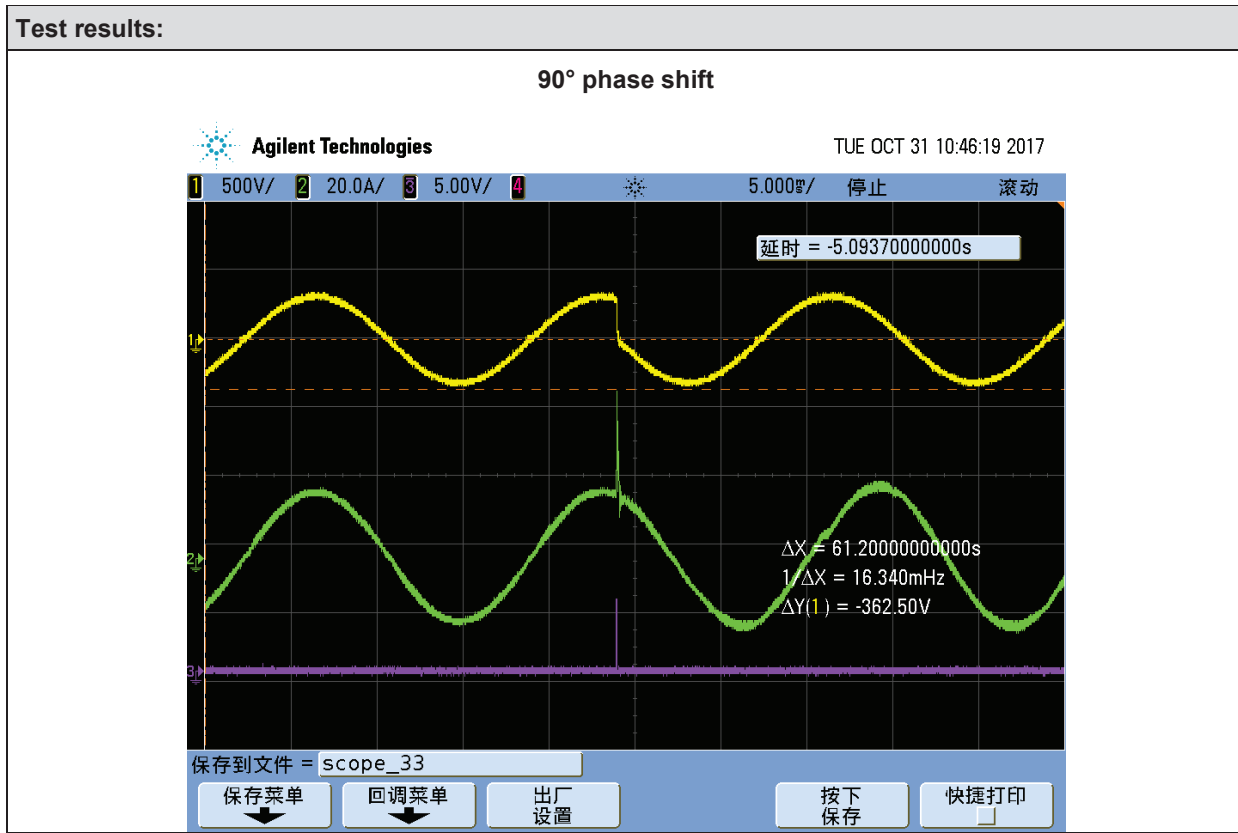

**6.11 Modulation of active power** **P**

**Graph of the setting accuracy:**

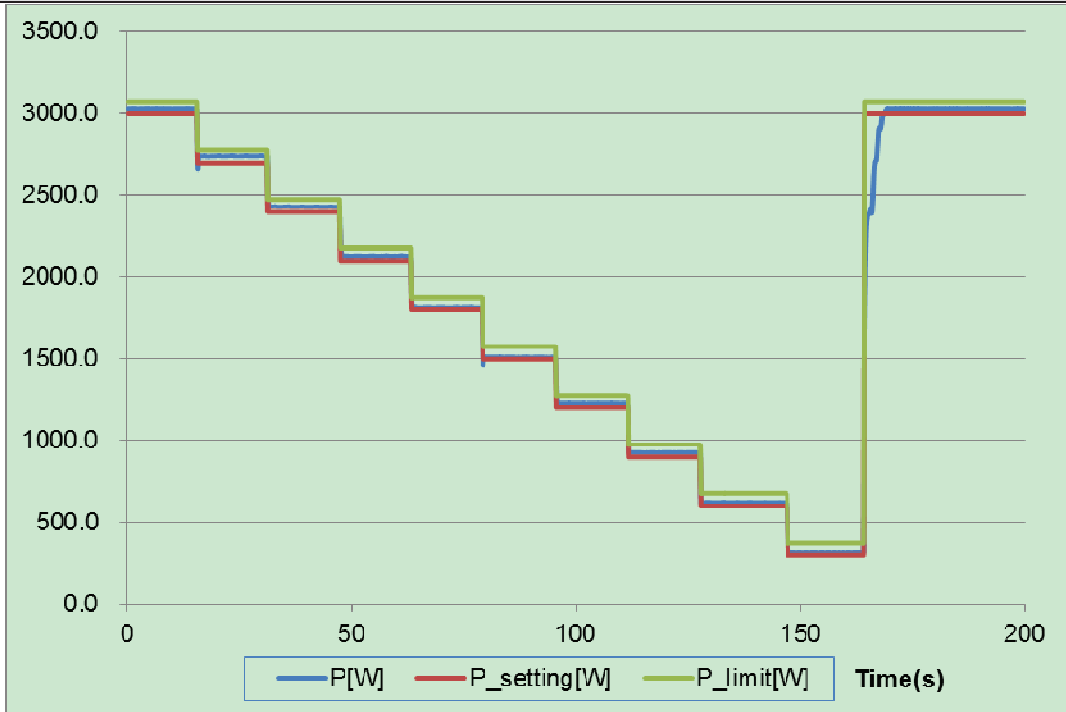

**Test:**

1-min mean value / P <sub>n</sub> /P [%]	100	90	80	70	60	50	40	30	20	10
P <sub>Setpoint</sub> [kW]:	3,000	2,700	2,400	2,100	1,800	1,500	1,200	0,900	0,600	0,300
P <sub>E60</sub> [kW]:	3,028	2,741	2,432	2,125	1,818	1,511	1,231	0,926	0,620	0,313
ΔP <sub>E60</sub> /P <sub>Setpoint</sub> [%]:	0,922	1,365	1,076	0,847	0,608	0,364	1,044	0,862	0,657	0,426
<b>Limit</b> ΔP <sub>E60</sub> /P <sub>Setpoint</sub> :	+ 2,5 % of P <sub>E<sub>max</sub></sub>									

**Note:**

A photovoltaic system with rated power greater than 6 kW shall be capable of reducing the active power injected into the grid by means of remote commands originating from the grid operator.

The adjustment values sent by the grid operator are expressed as a percentage of the rated power of the system, in increments with a maximum amplitude of 10%. If the system has a lower active power level than required, the active power output may not be reduced further.

The active power required by the external command shall be reached within a maximum of 1 min following receipt of the signal, with a tolerance of ± 2.5% of the rated power of the system.

<b>6.12 Modulation of reactive power</b>	<b>P</b>
--	----------

	Reactive Power set point Q/P <sub>n</sub> [%]	Measured reactive power Q/P <sub>n</sub> [%]	Deviation compared to setpoint ΔQ/P <sub>n</sub> [%]
-Q <sub>min</sub>	-48,43	-48,86	0,43
0	0	1,98	-1,98
+Q <sub>max</sub>	+48,43	48,15	0,72

**Graph**

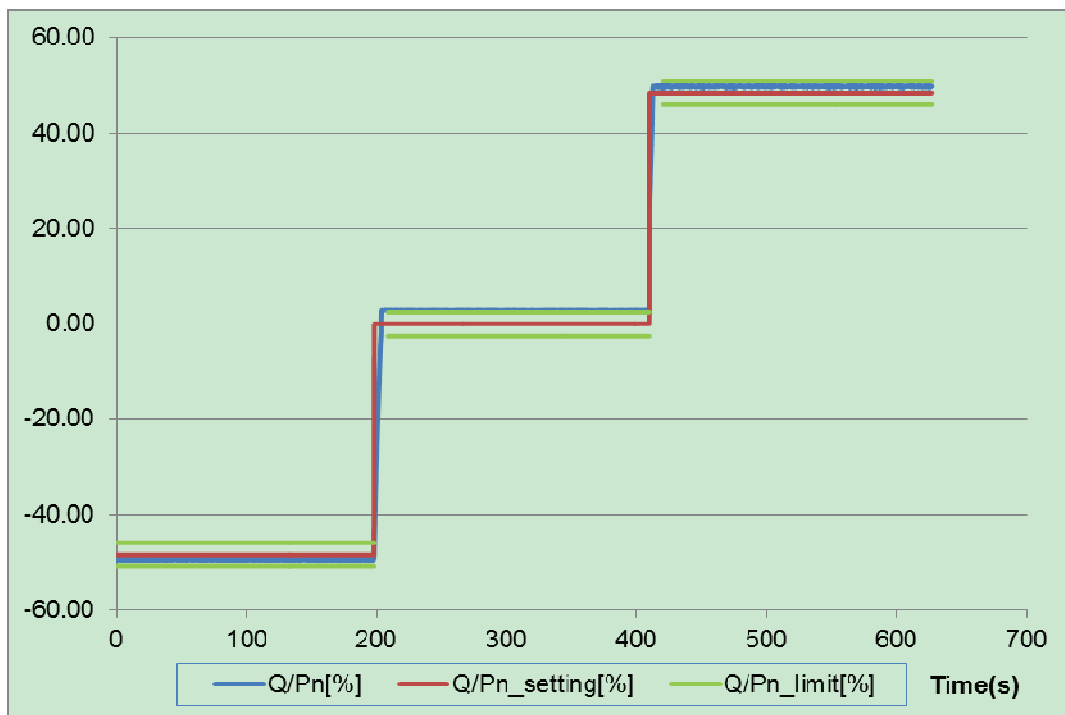

**Note:**

A photovoltaic system with rated power greater than 6 kW shall be capable of regulating the reactive power injected/demanded by means of remote commands originating from the grid operator.

The reactive power required by the external command shall be reached within a maximum of 10 s following receipt of the signal, with a tolerance of ± 2.5% of the rated power of the system.

### 6.13 Disconnection of the PV system network

P

With the evolution of distribution networks for the smart grid paradigm (smart grid), signals for the control of the distribution network are used. These signals should allow:

- modulation of active and reactive power generated by the PV system, as required by network operator;
- disconnection of the PV system from the network, if required by the network operator;

In the absence of a defined protocol for external control commands, manufacturers are free to choose it. After setting a standard communication protocol, through resolution rules, interfaces should meet the requirements.

It is the responsibility of the manufacturer of the EUT to provide a way of sending, receiving and processing the external control signal to the test.

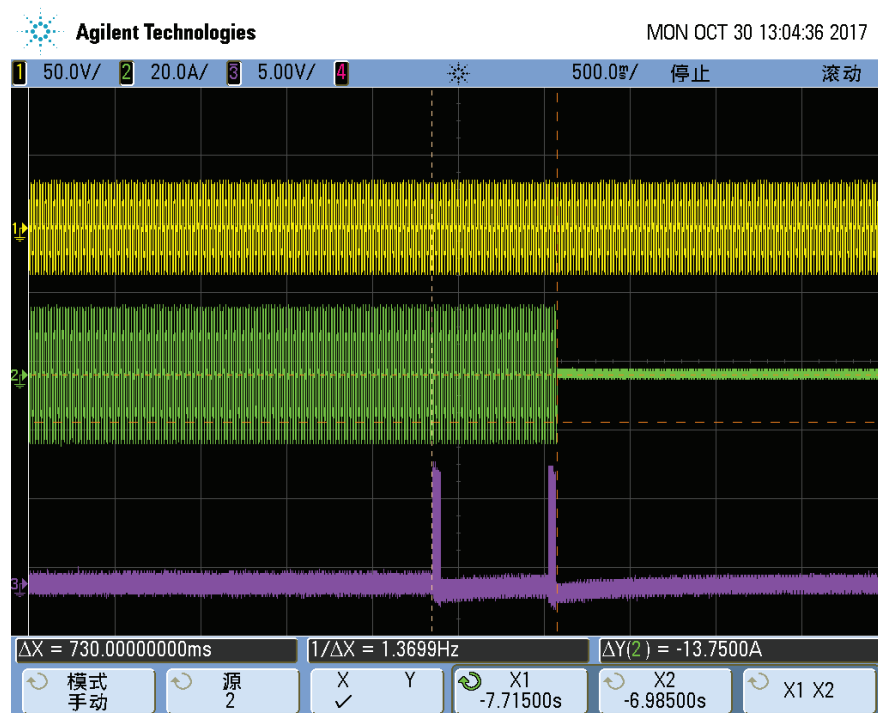

**Note:**

The photovoltaic system shall be capable of disconnecting from the grid by means of remote commands originating from the grid operator.

Disconnection shall take place within a maximum of 1 min following receipt of the remote command.

7. Islanding protection according IEC 62116:2008		
Test circuit and parameters		
Parameter	Symbol	Units
<b>EUT DC Input</b>		
DC voltage	$V_{DC}$	V
DC Current	$I_{DC}$	A
DC Power	$P_{DC}$	W
<b>EUT AC output</b>		
AC voltage	$V_{EUT}$	V
AC current	$I_{EUT}$	A
Real power	$P_{EUT}$	W
Reactive power	$Q_{EUT}$	VA <sub>r</sub>
<b>Test Load</b>		
Resistive load current	$I_R$	A
Inductive load current	$I_L$	A
Capacitive load current	$I_C$	A
<b>AC (utility) power source</b>		
Utility real power	$P_{AC}$	W
Utility reactive power	$Q_{AC}$	VA <sub>r</sub>
Utility current	$I_{AC}$	A

Block diagram test circuit IEC 62116:2008

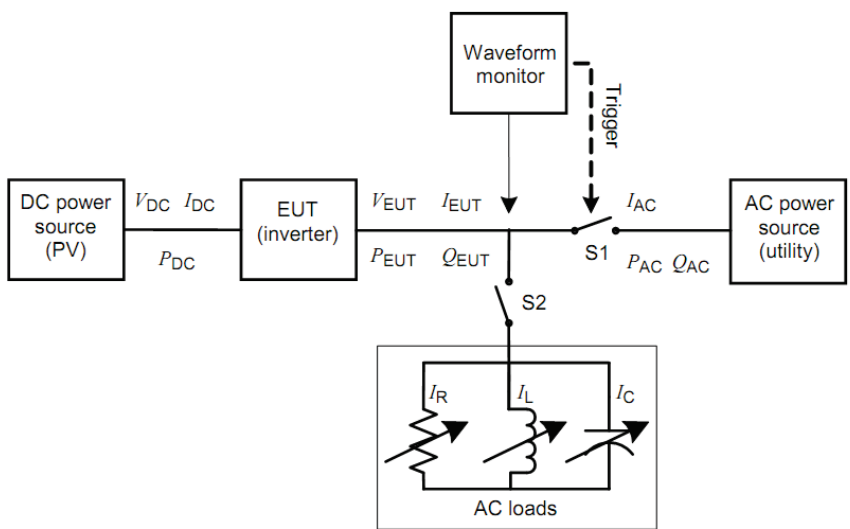

IEC 1567/08

**Figure 1 – Test circuit for islanding detection function in a power conditioner (inverter)**



7.1 Islanding protection according table 6 - Load imbalance (real, reactive load) for test condition A (EUT output = 100%)									P
Test conditions		Frequency: 60+/-0,1Hz U <sub>N</sub> =220+/-3Vac Distortion factor of chokes < 2% Quality =1							
Disconnection limit		2s (IEC 62116)							
No	P <sub>EUT</sub> <sup>1)</sup> (% of EUT rating)	Reactive load (% of Q <sub>L</sub> in 6.1.d) 1)	P <sub>AC</sub> <sup>2)</sup> (% of nominal)	Q <sub>AC</sub> <sup>3)</sup> (% of nominal)	Run on Time (ms)	P <sub>EUT</sub> (kW)	Actual Q <sub>f</sub>	V <sub>DC</sub>	Remarks <sup>4)</sup>
1	100	100	0	0	257	2998	1.014	443	Test A at BL
8	100	100	-5	-5	123	2998	1.041	443	Test A at IB
9	100	100	-5	0	211	2998	1.068	443	Test A at IB
10	100	100	-5	+5	84	2998	1.094	443	Test A at IB
13	100	100	0	-5	128	2998	0.989	443	Test A at IB
14	100	100	0	+5	79	2998	1.039	443	Test A at IB
17	100	100	+5	-5	153	2998	0.942	443	Test A at IB
18	100	100	+5	0	167	2998	0.966	443	Test A at IB
19	100	100	+5	+5	77	2998	0.990	443	Test A at IB
Parameter at 0%		L= 43.58mH		R= 16.85 Ω		C= 157.95 μF			
<p><b>Note:</b>            RLC is adjusted to min. +/-1% of the inverter rated output power  <sup>1)</sup> P<sub>EUT</sub>: EUT output power  <sup>2)</sup> P<sub>AC</sub>: Real power flow at S1 in Figure 1. Positive means power from EUT to utility. Nominal is the 0 % test condition value.  <sup>3)</sup> Q<sub>AC</sub>: Reactive power flow at S1 in Figure 1. Positive means power from EUT to utility. Nominal is the 0 % test condition value.  <sup>4)</sup> BL: Balance condition, IB: Imbalance condition.</p> <p>Condition A:            EUT output power P<sub>EUT</sub> = Maximum <sup>5)</sup>            EUT input voltage <sup>6)</sup> = &gt;90% of rated input voltage range</p> <p><sup>5)</sup> Maximum EUT output power condition should be achieved using the maximum allowable input power. Actual output power may exceed nominal rated output.  <sup>6)</sup> Based on EUT rated input operating range. For example, If range is between X volts and Y volts, 90 % of range = X + 0,9 × (Y – X). Y shall not exceed 0,8 × EUT maximum system voltage (i.e., maximum allowable array open circuit voltage). In any case, the EUT should not be operated outside of its allowable input voltage range.</p>									

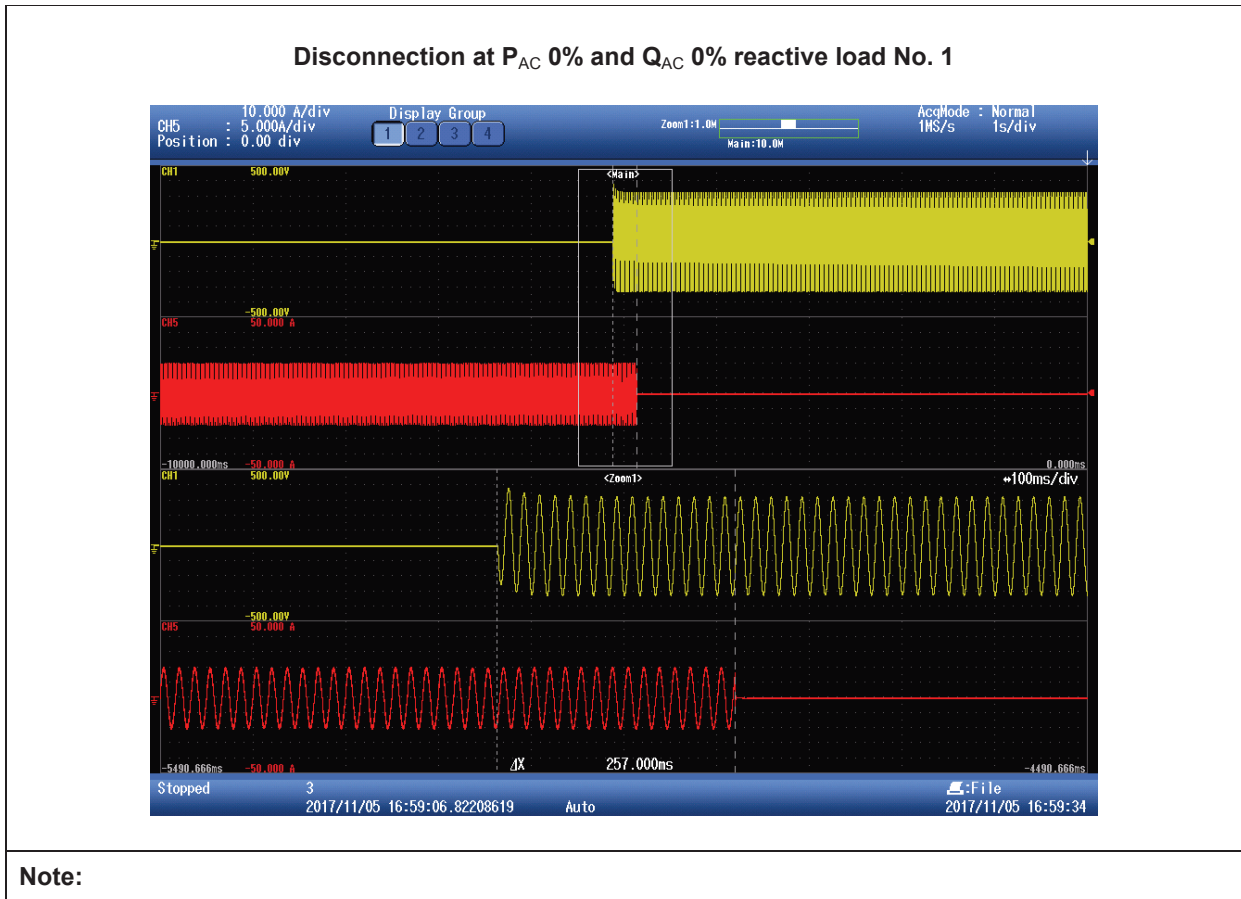

**Note:**

7.1 Islanding protection according Table 7 – Load imbalance (reactive load) for test condition B (EUT output = 50 % – 66 %)									P
Test conditions		Frequency: 60+/-0,1Hz U <sub>N</sub> =220+/-3Vac Distortion factor of chokes < 2% Quality =1							
Disconnection limit		2s (IEC 62116)							
No	P <sub>EUT</sub> <sup>1)</sup> (% of EUT rating)	Reactive load (% of Q <sub>L</sub> in 6.1.d) 1)	P <sub>AC</sub> <sup>2)</sup> (% of nominal)	Q <sub>AC</sub> <sup>3)</sup> (% of nominal)	Run on Time (ms)	P <sub>EUT</sub> (kW)	Actual Qf	V <sub>DC</sub>	Remarks <sup>4)</sup>
1	66	66	0	-5	131	1850	0.993	295	Test B at IB
2	66	66	0	-4	138	1850	0.999	295	Test B at IB
3	66	66	0	-3	198	1850	1.004	295	Test B at IB
4	66	66	0	-2	228	1850	1.009	295	Test B at IB
5	66	66	0	-1	271	1850	1.014	295	Test B at IB
6	66	66	0	0	209	1850	1.019	295	Test B at BL
7	66	66	0	1	192	1850	1.024	295	Test B at IB
8	66	66	0	2	101	1850	1.029	295	Test B at IB
9	66	66	0	3	109	1850	1.034	295	Test B at IB
10	66	66	0	4	90	1850	1.039	295	Test B at IB
11	66	66	0	5	85	1850	1.044	295	Test B at IB
Parameter at 0%		L= 74.64 mH		R= 28.91 Ω		C= 92.77 μF			
<p><b>Note:</b>            RLC is adjusted to min. +/-1% of the inverter rated output power  <sup>1)</sup> P<sub>EUT</sub>: EUT output power  <sup>2)</sup> P<sub>AC</sub>: Real power flow at S1 in Figure 1. Positive means power from EUT to utility. Nominal is the 0 % test condition value.  <sup>3)</sup> Q<sub>AC</sub>: Reactive power flow at S1 in Figure 1. Positive means power from EUT to utility. Nominal is the 0 % test condition value.  <sup>4)</sup> BL: Balance condition, IB: Imbalance condition.            Condition B:            EUT output power PEUT = 50 % – 66 % of maximum            EUT input voltage <sup>5)</sup> = 50 % of rated input voltage range, ±10 %  <sup>5)</sup> Based on EUT rated input operating range. For example, If range is between X volts and Y volts, 90 % of range =X + 0,5 × (Y – X). Y shall not exceed 0,8 × EUT maximum system voltage (i.e., maximum allowable array open circuit voltage). In any case, the EUT should not be operated outside of its allowable input voltage range.</p>									

Disconnection at  $P_{AC}$  0% and  $Q_{AC}$  0% reactive load No. 6



Note:

6.1 Islanding protection according Table 7 – Load imbalance (reactive load) for test condition C (EUT output = 25 % – 33 %)									P
Test conditions		Frequency: 60+/-0,1Hz U <sub>N</sub> =220+/-3Vac Distortion factor of chokes < 2% Quality =1							
Disconnection limit		2s (IEC 62116)							
No	P <sub>EUT</sub> <sup>1)</sup> (% of EUT rating)	Reactive load (% of Q <sub>L</sub> in 6.1.d) 1)	P <sub>AC</sub> <sup>2)</sup> (% of nominal)	Q <sub>AC</sub> <sup>3)</sup> (% of nominal)	Run on Time (ms)	P <sub>EUT</sub> (kW)	Actual Q <sub>f</sub>	V <sub>DC</sub>	Remarks <sup>4)</sup>
1	33	33	0	-5	156	965	0.989	147	Test C at IB
2	33	33	0	-4	182	965	0.994	147	Test C at IB
3	33	33	0	-3	213	965	0.999	147	Test C at IB
4	33	33	0	-2	195	965	1.004	147	Test C at IB
5	33	33	0	-1	143	965	1.010	147	Test C at IB
6	33	33	0	0	242	965	1.015	147	Test C at BL
7	33	33	0	1	199	965	1.020	147	Test C at IB
8	33	33	0	2	108	965	1.025	147	Test C at IB
9	33	33	0	3	118	965	1.030	147	Test C at IB
10	33	33	0	4	121	965	1.035	147	Test C at IB
11	33	33	0	5	108	965	1.040	147	Test C at IB
Parameter at 0%		L= 143.19 mH		R= 55.33 Ω		C= 48.14 μF			
<p><b>Note:</b>            RLC is adjusted to min. +/-1% of the inverter rated output power  <sup>1)</sup> P<sub>EUT</sub>: EUT output power  <sup>2)</sup> P<sub>AC</sub>: Real power flow at S1 in Figure 1. Positive means power from EUT to utility. Nominal is the 0 % test condition value.  <sup>3)</sup> Q<sub>AC</sub>: Reactive power flow at S1 in Figure 1. Positive means power from EUT to utility. Nominal is the 0 % test condition value.  <sup>4)</sup> BL: Balance condition, IB: Imbalance condition.            Condition C:            EUT output power PEUT = 25 % – 33 % <sup>5)</sup> of maximum            EUT input voltage <sup>6)</sup> = &lt;10 % of rated input voltage range  <sup>5)</sup> Or minimum allowable EUT output level if greater than 33 %.  <sup>6)</sup> Based on EUT rated input operating range. For example, If range is between X volts and Y volts, 90 % of range =X + 0,1 × (Y – X). Y shall not exceed 0,8 × EUT maximum system voltage (i.e., maximum allowable array open circuit voltage). In any case, the EUT should not be operated outside of its allowable input voltage range.</p>									

Disconnection at  $P_{AC}$  0% and  $Q_{AC}$  -1% reactive load No.5



Note:

# Annex 1

## Pictures of the unit

**Enclosure front view**



**Enclosure rear view**





### Enclosure bottom view

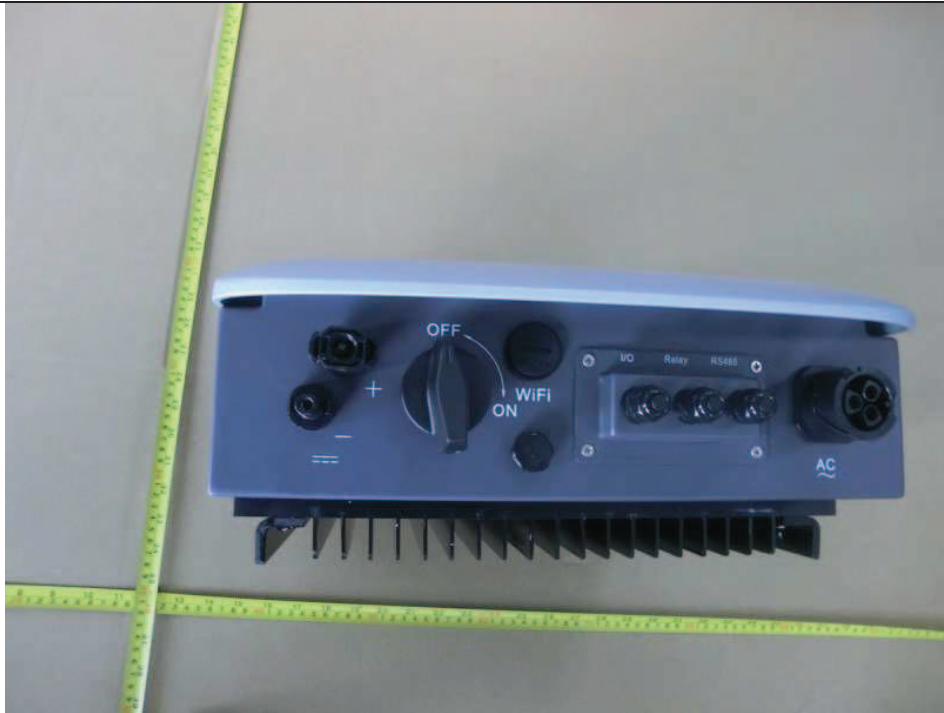

### Internal view-1

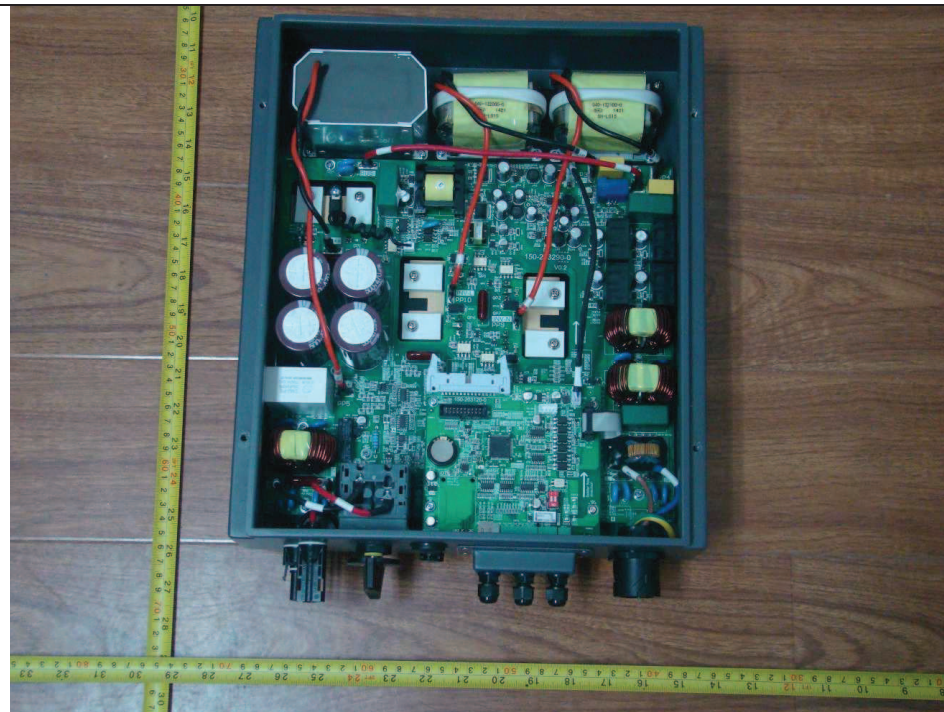

**Internal view-2**



**Internal view-3**

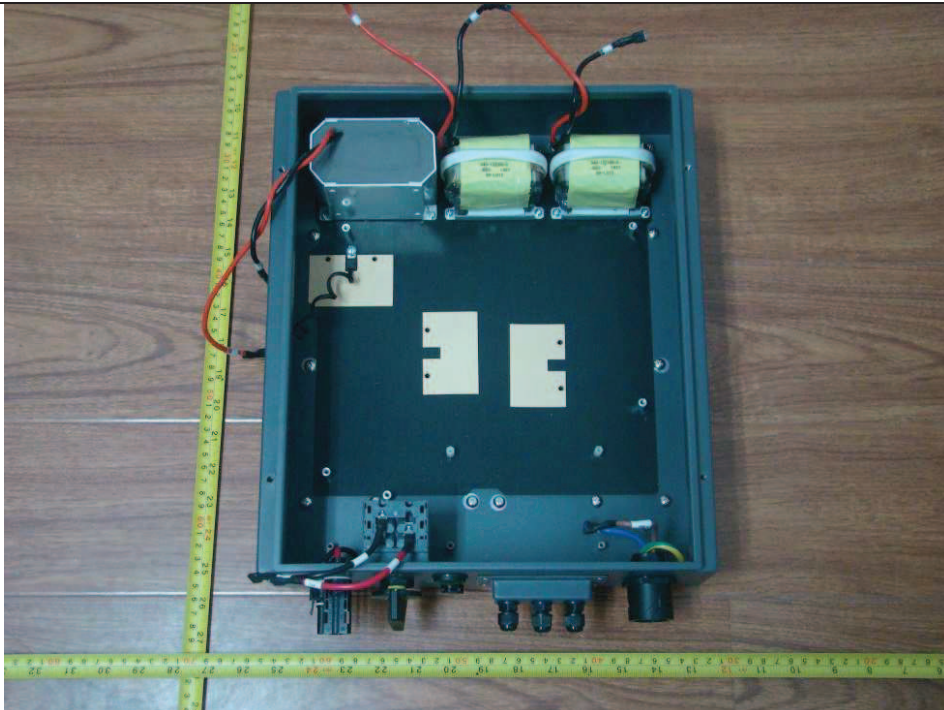

### Internal view-4



### Main power board component side view



### Main power board solder side view

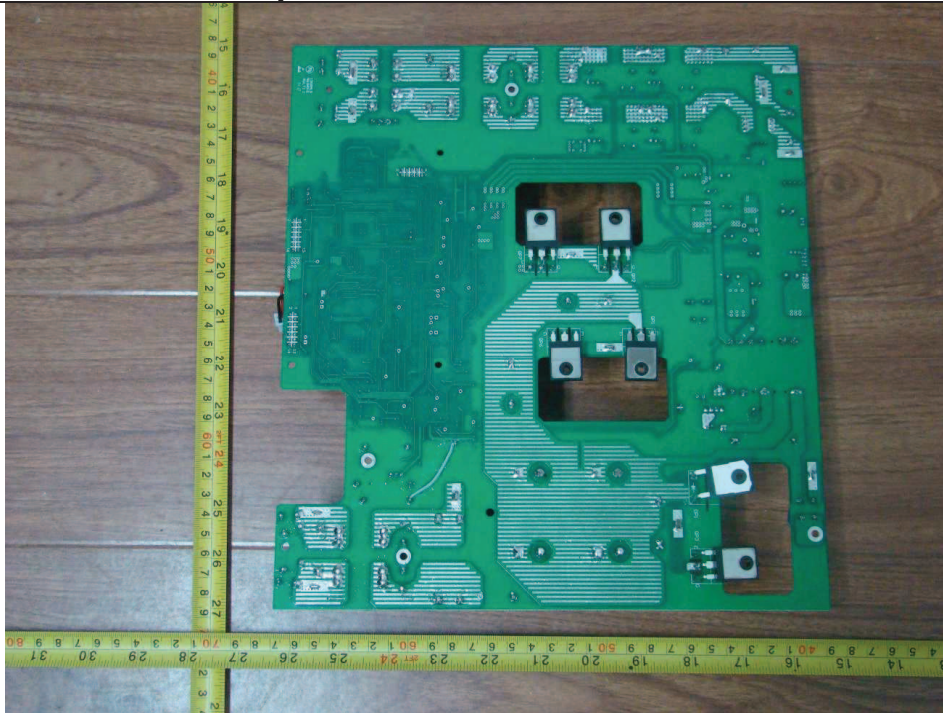

### Control board component side view

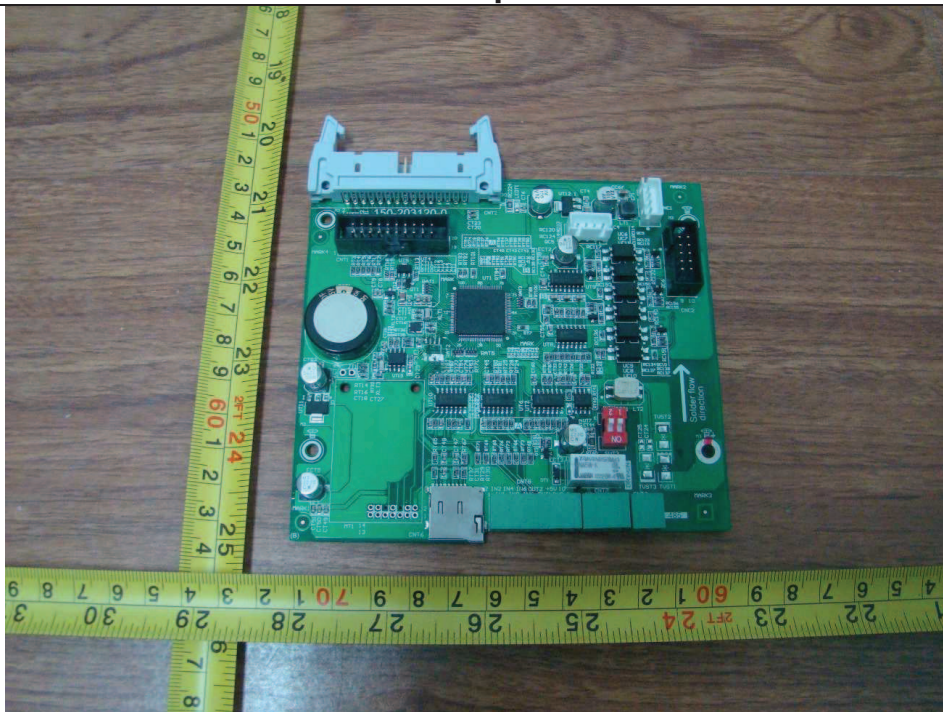

### Control board solder side view

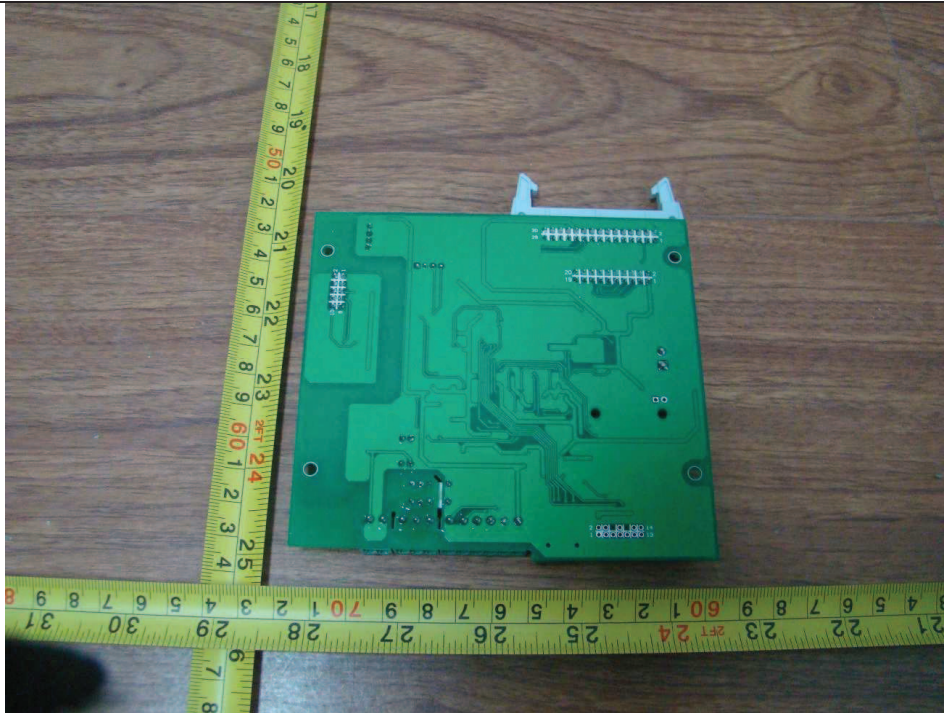

### Display board component side view

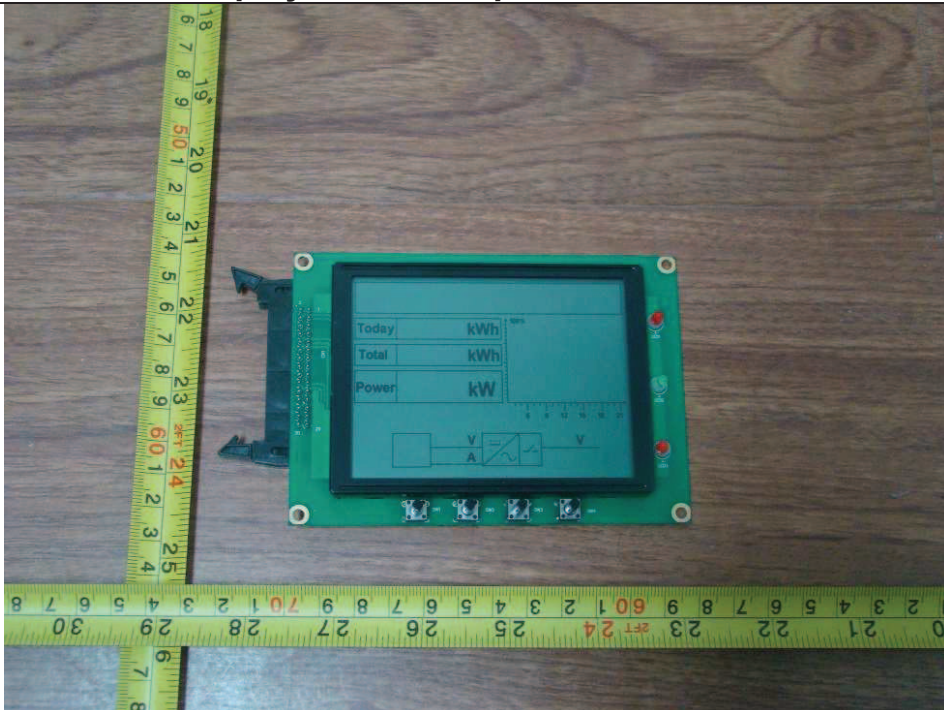

### Display board solder side view

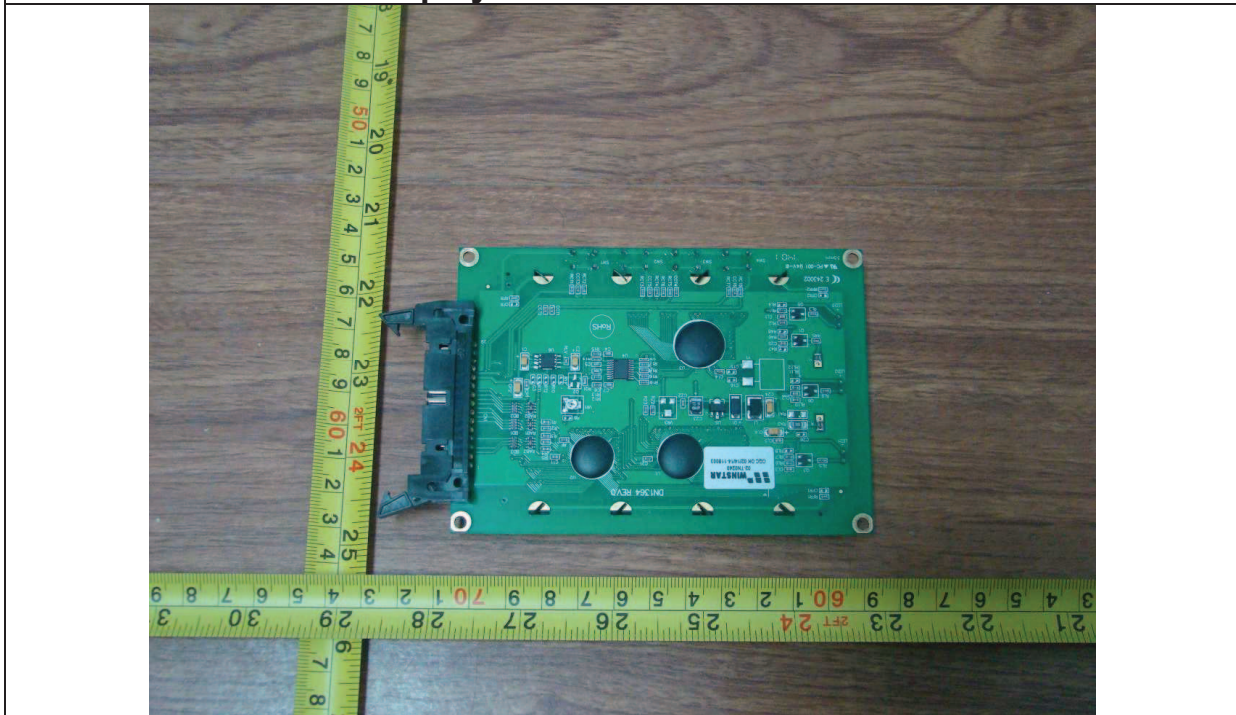

# Annex 2

## Test Equipment list

**Testing Location: Bureau Veritas Shenzhen Co., Ltd., Dongguan Branch**  
**Date(s) of performance test: 2017-10-19 till 2017-11-10**

Equipment	Internal No.	Manufacturer	Type	Serial No.	Last Calibration
AC Source	A7040019DG	Chroma	61512	61512000439	Monitored by Power Analyzer
	A7040020DG	Chroma	61512	61512000438	
DC Simulation Power Supply	A7040015DG	Chroma	62150H-1000S	62150EF00488	
	A7040016DG	Chroma	62150H-1000S	62150EF00490	
RLC Load	A7150027DG	Qunling	ACLT-3803H	93VOO2869	
Power Analyzer	A4080002DG	YOKOGAWA	WT3000	91M210852	Jan. 06, 2017
Current transducer	A1060007DG	YOKOGAWA	CT200	1130700012	Nov. 29, 2016
	A1060008DG	YOKOGAWA	CT200	1130700017	Nov. 23, 2016
Oscilloscope probel	A4089008DG	Tektronix	TPP1000	C008230	Dec. 15, 2016
	A4089009DG	Tektronix	TPP1000	C008231	Dec. 15, 2016
Digital Phosphor recorder	A4089017DG	YOKOGAWA	DL850-H-HC	91N726247	Sep. 01, 2017
	//	Agilent	DS05014A	MY50070266	Feb. 16, 2017